

DECEMBER, 1934

# RADIO RETAILING

INCLUDING  
SERVICE  
AND  
INSTALLATION  
SECTION

HOME ENTERTAINMENT MERCHANDISING

McGraw-Hill Publishing Company, Inc.

25 Cents Per Copy

## RCA VICTOR "MAGIC BRAIN" RADIO

### "AT LEAST A YEAR AHEAD OF COMPETING LINES!"

Every passing day and week adds to the utterly sensational triumph of RCA Victor's "Magic Brain" all-wave sets. Not just words... but crowds... interest... discussion... sales!

"Magic Brain" is the most powerful and instantaneous "natural" that has hit radio retailing in years.

It is the biggest thrill radio retailers have had in years... and you know perfectly well that the retailer is not kidding himself or letting himself be kidded, these days! Sales are providing the thrill—and the "Magic Brain" development is providing the sales.

"Selling 12 RCA Victors to 1 competing set" they write... "Business better than I thought it would ever be again"... "Surprising how the public is responding"... "Best-performing, best-looking sets we have ever seen"... "No mechanical difficulties at all"... "Whole line a knockout". Reports are reaching us in flood-proportions.

And how the "Magic Brain" advertising is hitting! Ads in 194 newspapers in 178 key cities... backed by millions of individual advertisements in such national publications as SATURDAY EVENING POST, COLLIER'S, AMERICAN WEEKLY, LITERARY DIGEST, LIBERTY, AMERICAN MAGAZINE, COSMOPOLITAN, NATIONAL GEOGRAPHIC, WOMAN'S HOME COMPANION, RED BOOK, TIME... powerful full pages... smashing double spreads... full colors... power plus!

### THE NET OF IT — from one dealer to another (Quoted from their letters)

Introducing the characters: A. W. OLSON, prospective RCA Victor dealer of Dodson, Montana, who wrote an inquiry about the Magic Brain line to Barber Music House, RCA Victor dealer of Great Falls, Montana, who replied (in part) as quoted below:

Frankly, I feel it is at least a year ahead of competing lines. We have handled radio since the very first... and I cannot recall at any time a product so far ahead of competition as RCA Victor this year. The 'Magic Brain' feature is, without question, the most outstanding advancement... since the superheterodyne circuit or the dynamic speaker. And they also have an exceptional battery radio this year. We have sold a great many... have experienced no mechanical difficulties at all... without question purchasers are more than enthused about their performance... I think it will surprise you how much business you can do."

(signed) R. J. BARBER,  
BARBER MUSIC HOUSE,  
Great Falls, Montana

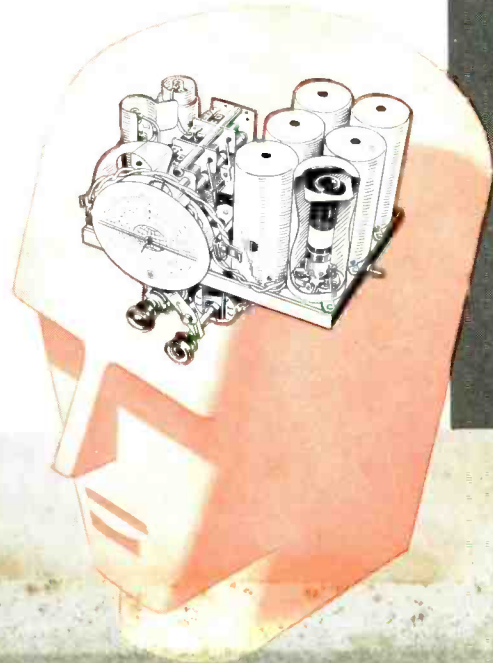

What are you doing about it... about your share?



# RCA VICTOR

RCA VICTOR CO., INC., CAMDEN, N. J.

A Radio Corporation of America Subsidiary

www.americanradiohistory.com

# There's a Rumor going 'round

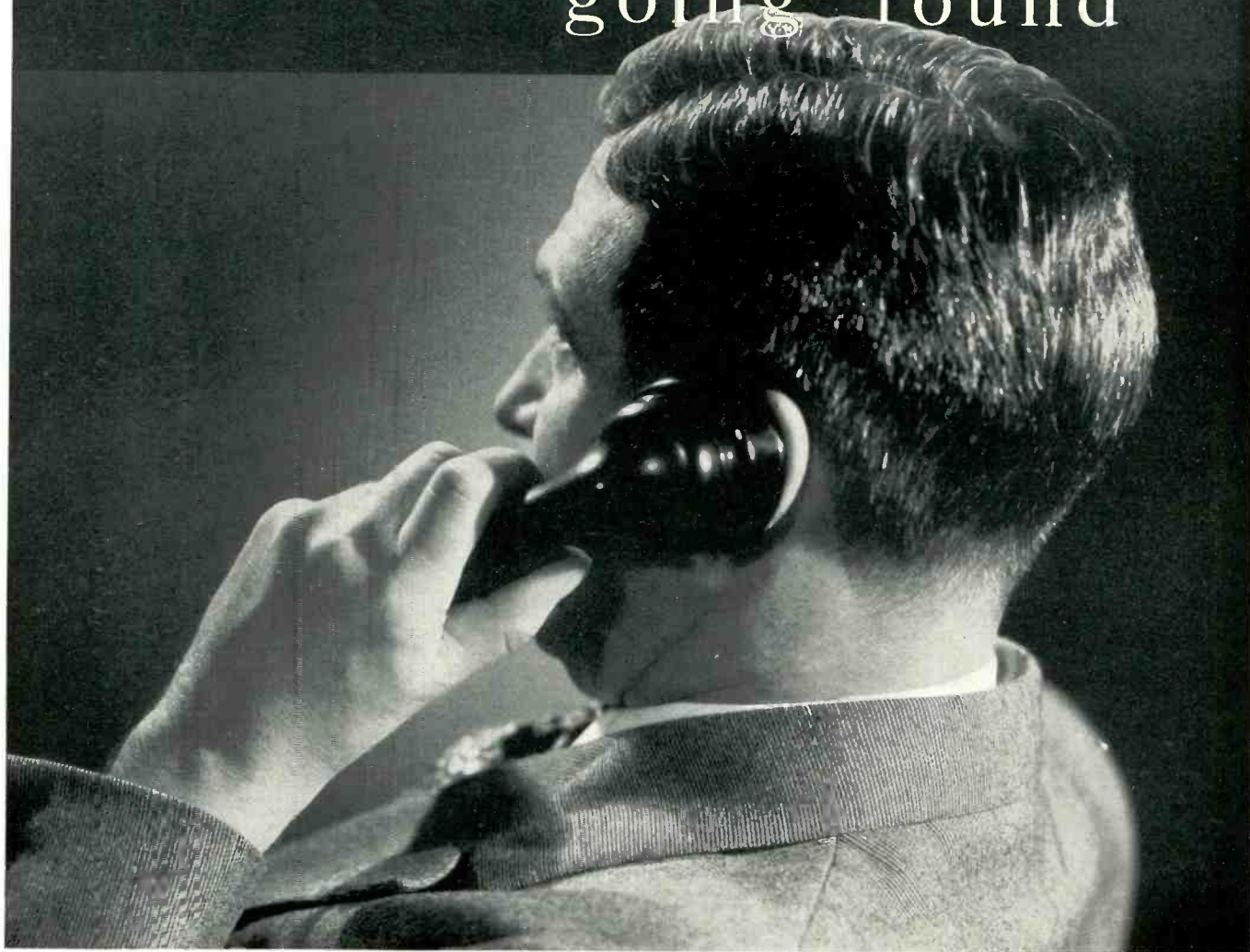

● There's a rumor going 'round that Frigidaire is about to make an announcement of vital importance to shrewd refrigeration dealers.

*This rumor is true.*

Frigidaire's Sales Plans for 1935 are almost ready. They embody, of course, all the principles that have proved sound and successful

in the past—and many new ideas as well.

If *you* want to stay on the "profit" side of the ledger by swinging along with the leader—now is the time to start.

A letter will bring you advance information. Write to Frigidaire Corporation, Subsidiary of General Motors Corporation, Dayton, Ohio.

# Frigidaire

PRODUCT OF GENERAL MOTORS

THE WORLD'S MOST POPULAR ELECTRIC REFRIGERATOR

RADIO RETAILING. December, 1934. Vol. 19, No. 12. Published monthly, price 25c. copy. Subscription rates—United States and Central and South American countries, \$2.00 a year. Canada, including duty, \$2.50 a year. All other countries \$3.00 a year or 12 shillings. Entered as second-class matter April 10, 1925, at Post Office at New York, N. Y., under the Act of March 3rd, 1879. Printed in U. S. A. Cable address "McGrawhill, New York." Member of A.B.P. Member of A.B.C. Copyright 1934 by McGraw-Hill Publishing Co., Inc., 320 West 42d Street, New York, N. Y.

Printed by The Schweinler Press, N. Y.



# ZENITH PRESENTS THE INSTRUMENT OF PERFECT MUSICAL RECEPTION

. . . *the Stratosphere*



25 Tubes

High Fidelity

\$750

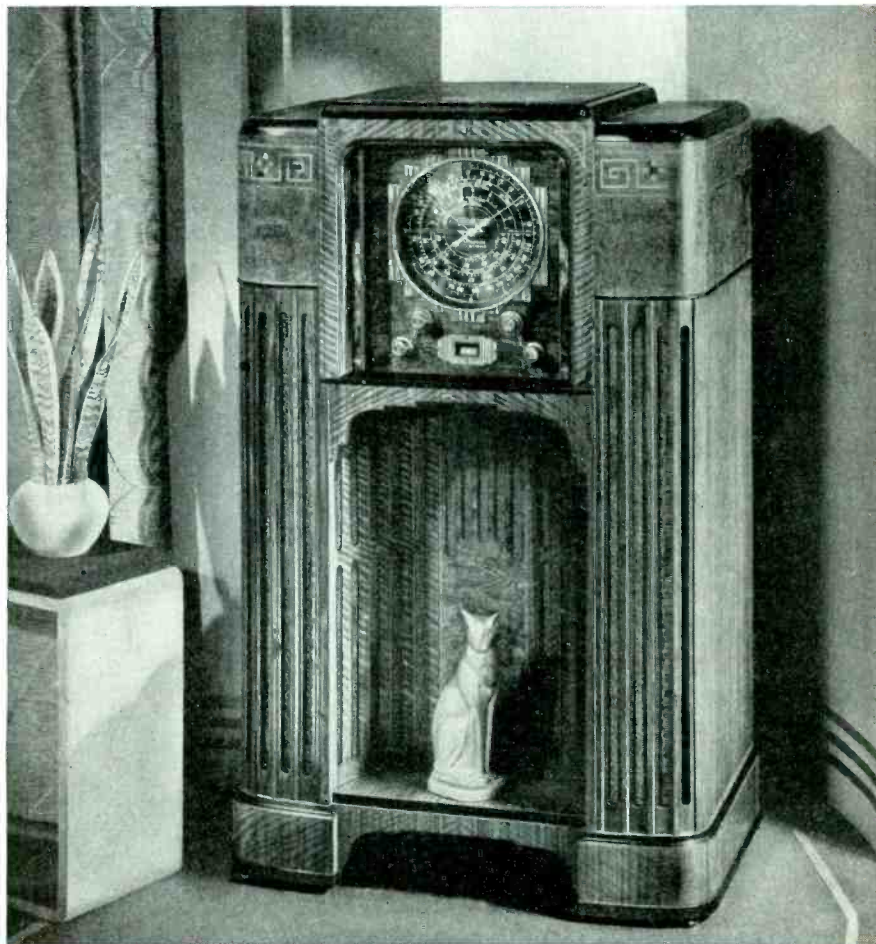

★ This great instrument definitely proves Zenith leadership in the field of modern radio reception. You sell *musical perfection* in an instrument produced by engineers who have made the name of Zenith famous.

It is easily the greatest radio performer you ever have demonstrated. The *Stratosphere* has 25 tubes, 3 speakers (2 Concert Dynamics and 1 High Frequency) and 5 wave-bands. It has a tuning range sufficient to get American and all foreign stations.

Tune it in low volume . . . you scarcely can hear its voice across the average room! In full volume it is powerful enough to fill the vast space of any school, church or club auditorium.

*Never once, from full to low volume, does the Stratosphere distort, or omit the rich, full warmth of every note that has come to the microphone . . . one mile or ten thousand miles away!*

Triple Filtering, designed to filter out the sputter,

crackle and noise that comes with long distance reception, has reached perfection in the *Stratosphere*. Its benefit in modern radio reception is here most clearly demonstrated. All the fine points of Zenith engineering and construction are clearly evident in this great new instrument.

We invite your inquiry about the *Stratosphere*.

ZENITH RADIO CORPORATION  
3620 Iron Street, Chicago, Ill.



EXPORT DIVISION — CABLE ADDRESS: ZENITHRAD — ALL CODES

# World-Ranging Radios . . .

## *Each leads in its class*

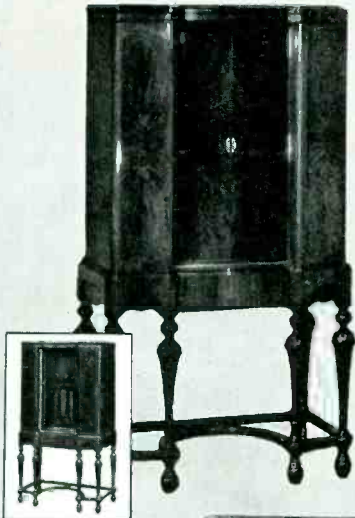

No. 60-H — Treasure Highboy. Foreign and American Broadcasts. 2-section Selectorlite Dial. Sliding doors. Walnut finish. Price, East of Rockies, \$135.00.



No. 60-T — Treasure Chest. Foreign and American Broadcasts. 2-section Selectorlite Dial. Finished in two tones of walnut. Price, East of Rockies, \$75.00.

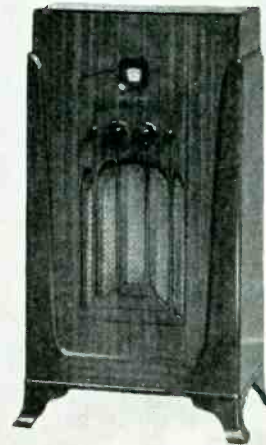

No. 60-LL — Treasure Console. Foreign and American Broadcasts. 2-section Selectorlite Dial. Finished in vertically grained walnut. Price, East of Rockies, \$99.50.

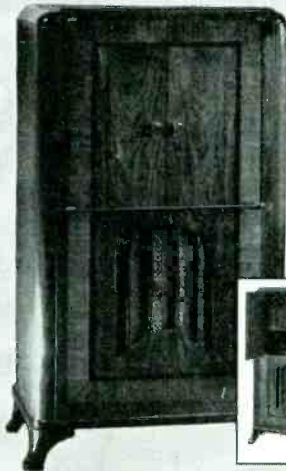

No. 60-PR — Treasure Console. Radio and Automatic Phonograph. 2-section Selectorlite Dial. Radio and phonograph controls available thru same doors. Walnut finish. Price, East of Rockies, \$245.00.



No. 68 — ALL-WAVE Radio. 4-section Selectorlite Dial covering from 540 to 23,000 kc. 15 watt output. Meter tuning. Walnut veneers with rosewood inlay. Price, East of Rockies, \$185.00.

The SIXTY SERIES, famed for extraordinary tone quality on both foreign and domestic programs . . . the No. 68, without doubt the most popular all-wave radio on the market. These radios cover every customer preference of style and price in the field of short wave-standard wave reception. Point for point, each one outranks competitors in its particular class. "There is nothing finer than a Stromberg-Carlson."

*Progressive dealers interested in allying themselves with the Stromberg-Carlson line are invited to write us.*

STROMBERG-CARLSON TELEPHONE MFG. CO., ROCHESTER, N. Y.

# Stromberg-Carlson





# EVERY FORM OF SALES PROMOTION to sell your service and tubes

Business comes to the dealer or serviceman who goes after it. The wide-awake radio dealer gains a big edge on competition through the constant use of the potent, sales-building Arcturus dealer helps. Arcturus sales promotion material is designed to build up your whole business generally and to establish your store as the radio service center of your community.

Just ask your Distributor to show you his elaborate portfolio of Arcturus dealer helps. You've never seen such a long list of sales and service helps... equipment deals, direct-mail campaign, displays, novelties, stationery, etc. Now you have an outstanding quality tube backed up by these outstanding helps.

Send the coupon today... we'll have our Distributor show you these aids to extra sales and extra profits.



Please check your favorite profit-helps below. Cut out list and coupon together, send both to us today:

- Characteristic Chart
- Price Card
- Radio Log and Price List
- Service Policy Card
- Ad Reprints
- Tube Stickers
- Book Matches
- Post Cards
- Stationery
- Portable Tube Tester
- Counter Tube Tester
- Dayrad Oscillator
- Dayrad Set Tester
- Rider's Manuals (incl. Vol. 5)
- Supreme Tube Tester (Neon lamp indicator)
- Supreme Analyzer
- Cuts and Mats
- Window Streamers
- Display Cartons and Tubes
- Window Display Units
- Electric Sign
- Decalcomania

**SEND COUPON & LIST TODAY**

# ARCTURUS RADIO TUBES

Pioneer of 6 out of the 7 Fundamental Developments in a. c. tubes.

ARCTURUS RADIO TUBE CO., Newark, N. J.  
I want to look over your big portfolio of dealers' sales and service helps.

Name .....

Street .....

City, State .....

Jobber's Name .....

Jobber's Address, City .....

# "I LIKE TO DO BUSINESS WITH SYLVANIA"

**"They've got a business policy that makes sense to me . . . a fine product, real profits to the dealer, plus strong sales support"**

*Read why this man made up his mind to sell Sylvania's above any other tube . . .*

● "I've been in the radio business eight years . . . and in that time I've learned one big thing. You've got to give every one of your customers the very finest in quality, or they'll wind up as somebody else's customers.

"This is one of the reasons I sell them Sylvania's. I know there's not a tube on the market that beats it. I know every Sylvania tube is a "first" . . . and that in purity and volume of tone, in fidelity of production, and in long life and economy, Sylvania Tubes rank with any other tubes in the world.

"Those are sweeping statements, I know . . . but after all, a tube can only be so perfect; and Sylvania tubes have behind them the skill of the engineers that made auto radio possible by developing the famous little 6.3 volt tube. Their research never ends.

"In addition, Sylvania has a business policy that makes sense to me. I always get strong sales support. I like the backing of a company that is run by the men who own the major part of the stock—a company with no absentee owners, which has held a rating of AaA1 even through the depression years. And best of all, a real worth while profit goes to every dealer who handles Sylvania Tubes.

Write for complete details. Hygrade Sylvania Corporation, Emporium, Pennsylvania.

Factories: Salem, Mass., Emporium, Pa., St. Mary's, Pa., Clifton, N. J.



Check the opinions of this man against what you yourself can prove about Sylvania tubes. First, quality. Second, sales support. Third, the company that makes them; and fourth, the profit that will go to you as the dealer.

# SYLVANIA

## THE SET-TESTED RADIO TUBE

©1934 H.S.C



The  
**STORY BEHIND  
 THE NEW 1935  
 FADA  
 Radio**



**MODEL 1462 D . . . . WORLD WIDE RADIO**

6 tube AC-DC superheterodyne. Tuning range 550-1500 KC and 5.8-15.5 MC. Receives foreign stations with amazing clarity and volume. Features include—illuminated aeroplane dial—full automatic volume control—variable tone control—phono jack—diode detection—8 tube performance—dynamic speaker. A small set that will outperform sets selling for twice its price.



**Model 1452 A  
 World Wide Radio**

Both of these sets contain the same chassis. 5 tube AC superheterodyne with tuning range of 550 to 1500 KC and 5.8 to 15.5 M.C. Features include illuminated aeroplane dial—full automatic volume control—variable tone control—phono jack—7 tube performance—dynamic speaker—diode detection. The cabinets are made from selected grain walnut. Both offer fine performance and exquisite beauty.

**Model 1452 F—World Wide Radio**

**New Fada Compact Radios for 1935**

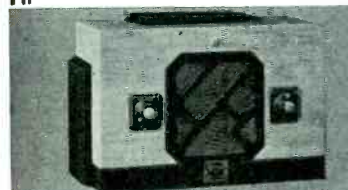

**Model 110 AM—4 Tube AC-DC**  
 Operates on any frequency. Moderne cabinet. Suede carrying case can be furnished.



**Model 130—5 Tube AC-DC**  
 Superheterodyne. Range 540-1700 KC. Features include 3 gang condenser and dynamic speaker.



**Model 140—6 Tube AC-DC**  
 3 gang superheterodyne—tone and volume control, extra sensitive and selective. Dynamic speaker. Operates on any frequency.

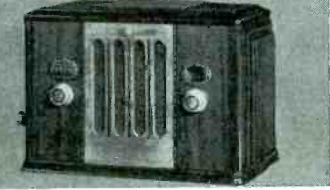

**Model 135—5 Tube AC-DC**  
 3 gang superheterodyne. Range 540-1700 KC. Features—built-in aerial—phono jack—dynamic speaker—6-tube efficiency.



**Model 1470 C  
 4-Band Radio**

Both of these sets contain the same highly efficient chassis. 4-band world wide 7 tube AC superheterodyne with 3 gang condenser operation on all bands. The very last word in radio performance. Receives American, European, aeroplane, police, ship, amateur and all short wave broadcasts. The console model features a specially constructed 12 inch speaker of superb tone quality. These two radios will set the pace in sales because they combine value and performance.

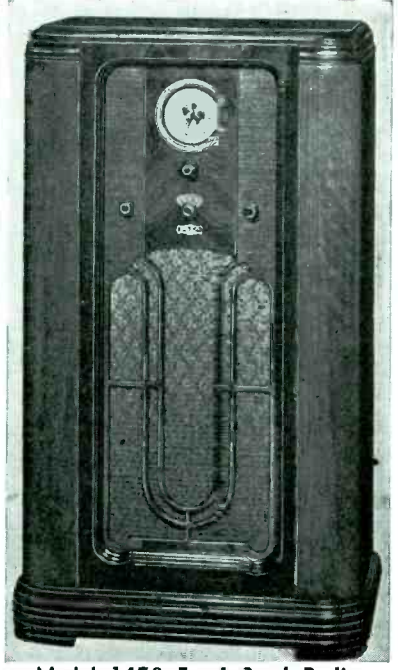

**Model 1470 E—4-3and Radio**

**Greater Profits!**

Legitimate competition means legitimate profits for the dealer. . . . that is the story behind the FADA PROFIT LINE for 1935. The FADA franchise will be limited in each territory . . . and will be extended to dependable dealers only. The Fada Policy of PROTECTED PROFITS will be rigidly maintained.

**Greater Values!**

The New FADA Radio line for 1935, priced from \$19.95 to \$124.75, are without question the value leaders in their respective price classes. No slow moving models in the new FADA line. Every dealer is assured of quicker turnover and greater volume for every dollar invested.

**Finer Quality!**

The new FADA radios for 1935 embody every known advance in radio science and engineering. They are the result of 15 years' experience building fine radio receivers. The world wide models are guaranteed to bring in foreign stations with clarity and volume. You can offer your clientele nothing finer than a FADA Radio.

**FADA RADIO & ELECTRIC COMPANY**

Cable Address  
 "FADARADIO"

**LONG ISLAND CITY—N. Y.**

# Here is a Barometer of **Quality**

**Tung-Sol Export Business has grown steadily, even faster than its Domestic Business**

**because Foreign Customers have found that**

- 1** Cheap tubes are most expensive, even when the manufacturer allows full credit—the import duty (many times equalling the cost of the tube) is a total loss when the tube fails to perform properly.
- 2** Shipments are sometimes six weeks in transit and much depends on satisfactory performance of the tubes when they are placed in waiting sockets.
- 3** Service calls are sometimes a matter of many miles rather than city blocks. The Price of the tube is relatively small compared to the cost of the call.

The quality and uniformity of Tung-Sol Radio Tubes has supplied the answer to the problem of many foreign customers.

Our 9,000 Retail Partners in the United States agree and confirm that there is no substitute for Tung-Sol quality and uniformity.



MADE BY THE MAKERS  
OF TUNG-SOL AUTOLAMP  
BULBS

**Send for full details of the time-tested Tung-Sol Consignment Plan**

# TUNG-SOL

*Flow radio Tubes*

TUNG-SOL RADIO TUBES INC., NEWARK, N. J.

Form T183

Atlanta Boston Charlotte Cleveland Chicago Dallas Detroit Kansas City Los Angeles New York



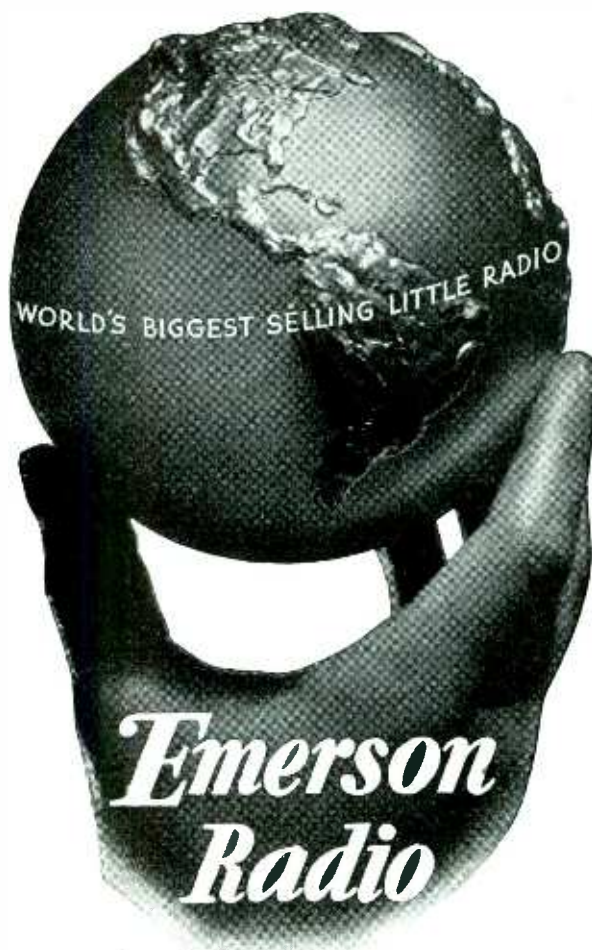

## Extending the Season's Greetings with a Promise for the Future

To all who have shared in Emerson's gratifying success during the past year . . . to all who will be with us in our continuing efforts to work out more and more constructive and profitable policies in radio production, distribution and sale . . . we extend our heartiest Christmas greetings and a pledge of still greater cooperation during the coming year.



Eleven EMERSON Models  
\$19.95 to \$99.50

Send for the EMERSON  
1935 Proposition

EMERSON RADIO AND PHONOGRAPH CORPORATION, 111 Eighth Ave., NEW YORK, N. Y.

# What do they mean PRECISION?

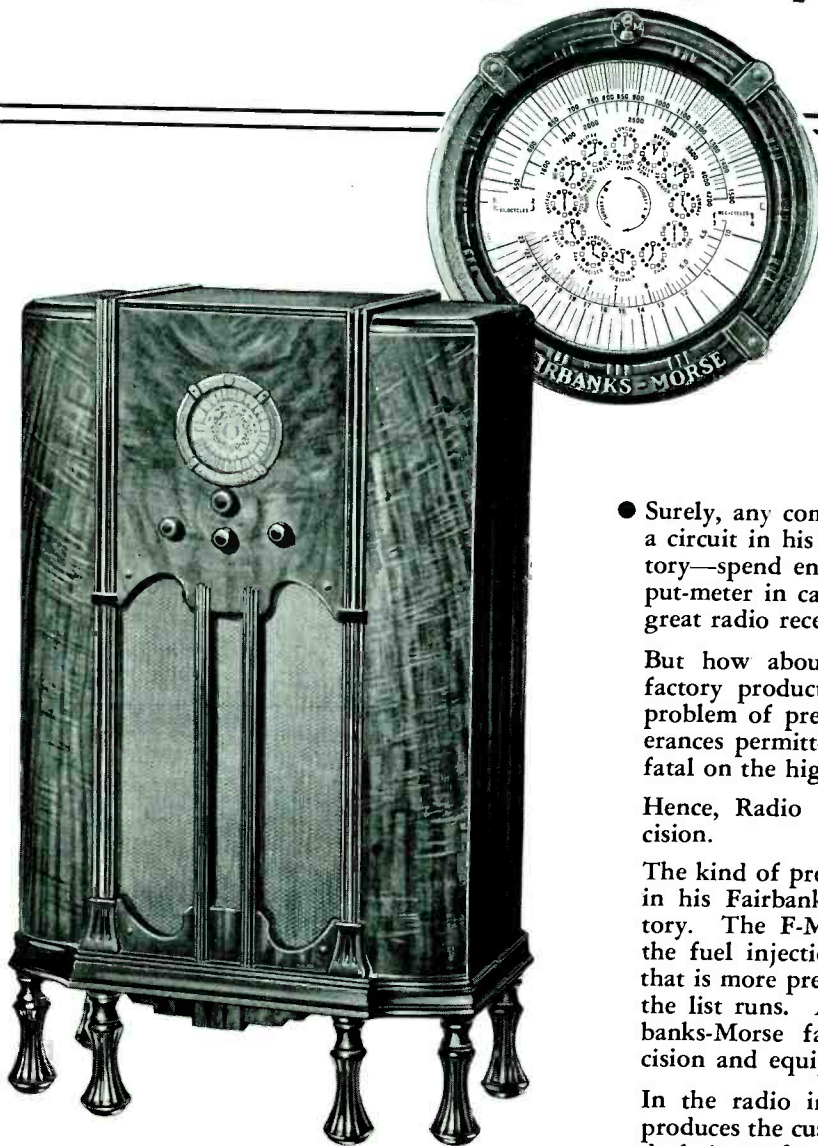

A Fairbanks-Morse Radio Receiver, representative of a complete line which dealers report as winning on competitive demonstration everywhere.

- Surely, any competent radio engineer can develop a circuit in his *laboratory*—build it in the laboratory—spend enough time with oscillator and output-meter in careful aligning and produce a truly great radio receiver *because* of its *precision*!

But how about getting laboratory precision in factory production? All-wave receivers make the problem of precision more acute than ever. Tolerances permitted in the broadcast band would be fatal on the higher frequencies.

Hence, Radio needs, *now*, Fairbanks-Morse precision.

The kind of precision that the scientist relies upon in his Fairbanks Scales in the university laboratory. The F-M kind of precision that regulates the fuel injection system of a Diesel engine and that is more precise than a jeweler's timepiece. So the list runs. Accuracy in production from Fairbanks-Morse factories long accustomed to precision and equipped to *maintain* it in production.

In the radio industry, Fairbanks-Morse accuracy produces the customer satisfaction that protects the dealer's profit.

Fairbanks-Morse Home Appliances, Inc., 430 S. Green St., Chicago, Ill.

## FAIRBANKS-MORSE



104 Years of  
Quality Products

## Home Appliances, INC.



# RADIO RETAILING

O. H. CALDWELL, Editor

RAY V. SUTLIFFE  
*Managing Editor*

W. W. MacDONALD  
*Associate Editor*

T. H. PURINTON  
*Assistant Editor*

HARRY PHILLIPS  
*Art Director*

M. E. HERRING  
*Manager*

PAUL WOOTON  
*Washington*

VOL. 19

DECEMBER

1 9 3 4

NO. 12

## M O M E N T U M

SET, tube and parts sales this fall are topping last year's record by approximately 35 per cent in dollar volume, according to telegraphic reports just received from radio men all over the country. It is estimated that sales for the first half of '35 will exceed even this amazing comeback.

*Radio Retailing* concurs in this optimistic prediction. It believes this viewpoint "bull proof" because it is based on a series of favorable underlying causes.

What are these causes, this aggregation of fortuitous circumstances that should inspire every radio dealer, jobber and manufacturer to open wide the promotion throttle and drive ahead under full steam? Consider these facts:

First, the general business outlook is immeasurably better. The industrial world has mobilized, cooperating with the Administration, to maintain and further the economic recovery already definitely discernible. Retail distribution, the bright spot of 1934, promises to accelerate its pace this winter. Steel production has increased 50 per cent, now exceeding the 1933 level. Automobile production is likely to start with a rush within the next thirty days. Agricultural prices, gasoline, cotton spinning, coal and electric power consumption and other basic indices, all are on the upgrade.

And the radio industry contributed its full share to this picture by producing sets which, in appearance and performance, definitely out-date 1933 and prior models. Open face dials, which tell the

public that worldwide reception may now be had; improved tonal performance and handsome cabinets predominate.

Because the manufacture and distribution of radio products is now in strong and experienced hands, dumping and price cutting no longer are so prevalent as to completely disrupt individual initiative.

ANOTHER significant factor is seen in the spirit of optimism at the recent convention of radio engineers at Rochester, New York. Many technical advancements are now in their final stages of development and shortly will make their commercial bow, assuring a continuance of public interest in the "new" receivers as well as in facsimile and possibly television. Thus radio's replacement market will be further stimulated.

That the radio manufacturers, as a body, feel that their business is now on a firm foundation is evidenced by the two All-Industry campaigns recently launched by the Radio Manufacturers Association. We refer to the national publicity plan and the national noise elimination drive. Both of these projects should be in full swing by the first of February.

Radio's comeback shows a percentage gain far ahead of most other industries. No business appears to have a brighter future. But every radio man must adhere to sound, constructive merchandising practices. Spineless selling is the only thing that will retard the momentum under which we enter the new year.

# Will They Laugh When They Unwrap the CELLOPHANE?



They **WON'T** if it's a **RADIO**  
...the continuously useful Christmas gift



Aunt Emma meant well when she picked out a Ben Hur lamp for Jane. She tried equally hard to please Jack with the hand painted Chinese idol. The cut-glass cheese dish and the antique back-scratcher were, presumably, selected with reasonable care by other well wishers imbued with the Yuletide spirit . . . BUT . . .

Fortunately, it's only the sentiment that counts. For the chariot-hero will be given away as a bridge prize. The mandarin will shortly contemplate his ancestors in some remote corner of the attic. The crystal fly-discourager will be stowed away on a topmost shelf. The vertebrae-agitator may, conceivably, be used . . . to fish canned goods down from out-of-reach pantry crannies.

How much better to convey best wishes with a gift that will really be *used*, continuously used! A radio fills the bill to perfection. For Jane and Jack and Junior will think of its sender every time they tune in. Even if they already have one, the new set will be genuinely useful in bedroom or play-room or den.

Truly, a radio is the very personification of useful Christmas gifts. And there is one to fit every pocketbook.



## STABILITY

*"Radio Retailing" Magazine:*

Due largely to the popularity of short wave there has been a definite improvement of the 1934 market. This active buying trend undoubtedly will continue well into 1935.

The only note that is lacking is that of assured stability of prices and contractual relationships. A fair schedule of prices, under the Code, would protect seller and buyer alike. It would assure just profits and place the radio business on a sound basis—which would create more jobs and thus contribute to the public benefit generally. Buying power is not going to be built up on an unstable price foundation, but rather by such measures as will keep business on the path of sure-footed progress.

It behooves every manufacturer and every dealer to stick to established prices. This is the most important industry job to be done this coming year.

Very truly yours,

THE JAMES BAILEY COMPANY  
per C. J. Bailey, Treas.  
Portland, Maine

## QUESTION—

"I am a 'sound' engineer. How can I cash in on this knowledge?"

To the Editor of *Radio Retailing*:

I am contemplating taking up the sale of radio sets and would like a little advice. Our downtown stores cannot demonstrate all-wave sets. I am thinking of opening up in an outlying section where I can demonstrate just what real good reception sounds like. Open until midnight and make a play for the folks who like to have some place to go after supper. Is anyone doing this and with what results?

The selling of sets seems to be submerged in too much technical jargon. As I am a former sound engineer who used to worry if the equipment lost a decibel at 4500 cycles, I can't see how salesmen can demonstrate true tone by turning the control on full. Maybe I will throw the receiver off peak and add an audio equalizer. How do they get anyone to trade in an old set when the new one sounds almost as bad?

Sincerely,

KEITH LA BAR  
Los Angeles, California

## OUR ANSWER—

Dear Mr. La Bar:

Your letter of November 10 inspires us to reply as specifically as possible inasmuch as you open up a field of thought in the retailing of radio sets which has interesting possibilities.

If I were in your position, with your specific knowledge of the technical qualifications necessary to demonstrate convincingly to a consumer the difference in tonal qualities of sets, I believe I would run a store in an outlying section where reception conditions are ideal and try it out. You will have no difficulty in getting customers to come to your store if there is a special reason for doing so. This has been shown time and again by the experience of other retailers in suburban communities. If I were you I would arrange a convincing demonstration and would advertise that I specialize in the matter of "tone knowledge."

Signed:

R. V. SUTLIFFE  
Managing Editor, "Radio Retailing"

*Editor's Note: Did we advise Mr. La Bar correctly?*

# These 3 Rooms

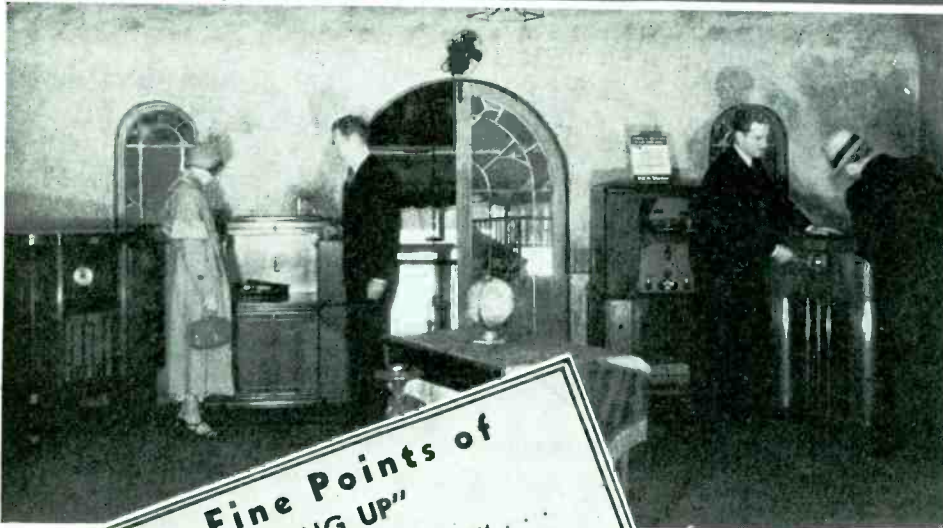

## The Fine Points of "SELLING UP"

The Hancock Music Company . . .  
**CLASSIFIES** its sets into three price range groups  
**SEGREGATES** each group in a separate room  
**SEES** that the prospect is comfortably seated  
**CONCENTRATES** on two types of receivers—the "ace in the hole" game  
**TALKS FRANKLY** about the limitations of the lower priced sets  
**COMPARES** tonal qualities  
**LETS THE CUSTOMER** actually buy a cheaper model—and then sells him up  
**PUSHES** the radio-phonograph with moneyed people  
**HAS** an outside partner-salesman for every floor clerk  
**WASTES NO TIME** following those who decline to leave their name

*Customers and salesmen in the high priced radio room of the Hancock Music Company, Pasadena, Calif.*



*Robert E. Mosher demonstrable models to a woman who*

**T**HE radio department of the Hancock Music Company, Pasadena, Calif., is housed in three rooms, each 20 feet square. In the first are the cabinet models, in the middle room are the table sets and in the last, the used receivers. Regardless of the price the prospect has in mind, he or she must first pass through the console room. These rooms, on the mez-

zanine, are jointly in the charge of Robert Mosher and R. L. Prescott. We'll let them explain their "three-room" sales technique in their own way:

"Hancock sells eight out of ten persons who come into its store to look at radios. Three out of every ten who first decide on a table model are switched to a cabinet before they leave the store. More than half



## Sell 8 Out of 10 Prospects.

### Switch 5 Out of 10 to Higher Priced Models

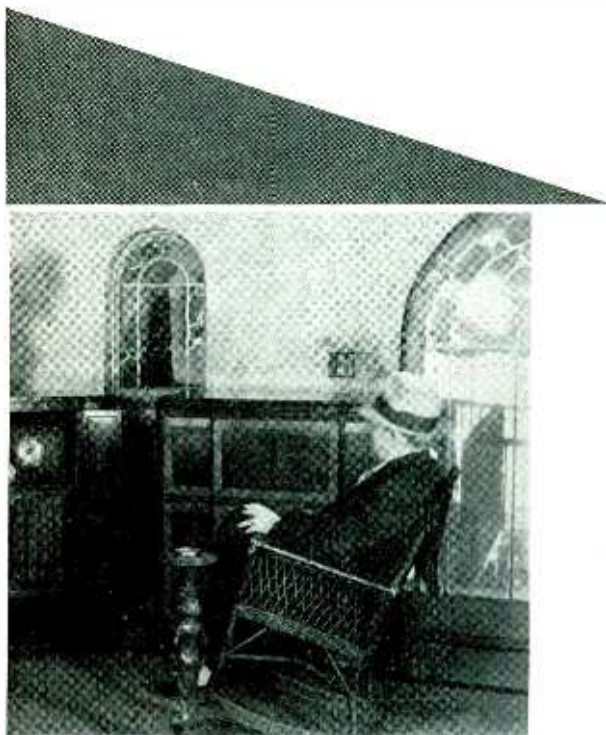

R. L. Prescott tuning in a medium-priced set for a customer



strating one of the better thought she wanted a midget

of those who buy leave with a higher priced set than they originally had in mind.

"How are these things done?"

"Let us assume that the customer has in mind a \$16.75 midget. He is taken into the middle room, where, on a shelf down one side of the room, are our low-priced models. On a similar shelf on the opposite

side of the room are higher priced models, some selling for as much as \$80.

"The first thing we do is to draw up a chair facing the radio receivers in the price range mentioned by the customer and ask him to be seated. We explain that, since we carry so many complete lines, further looking around will be unnecessary, and that he may as well be comfortable and take all the time he wants in making his selection. Then we concentrate our selling efforts on *two* makes of radios, instead of just one. We sell both hard; then suggest that the customer choose the one whose tone qualities please him most, and the one whose cabinet appeals to him the most. Sometimes the cabinet of one appeals and the tone qualities of another, whereupon we feel privileged to show him something outside the specified price range in hopes that we can find a model which embraces pleasing tone and appearance—and *this set is certain to be higher in price.*

"We frankly tell the prospect that, whereas he may be satisfied for a few days with the results obtained from a low-priced set, he will eventually tire of its tinpanniness—yes, we use that word without compunction—and then he'll let it stand idle for days at a time. We assure him that there are thousands of silent sets, silent because their owners cannot stand their rasping tone qualities. We suggest that he spend a few dollars more and obtain a set that will give him pleasure.

"Should he counter with the assertion that he only wants it for a bedroom anyway, we immediately call his attention to models that have been especially constructed for bedrooms. They sell for more than \$30.

"If, on the other hand, he admits that the arrangements in his home will not accommodate a cabinet set and therefore he must have a table model, we draw his attention to the higher-priced sets on the other side of the room. We compare the tone qualities of these sets with the cheaper varieties, going to great length to explain the factors governing tone quality. We find that the majority of the customers evince interest in such an explanation.

"IT IS sometimes advisable to let the customer buy a table model even though his home will accommodate a cabinet model. So we close the transaction, make out the necessary papers, get them signed and start downstairs with the customer. As we pass through the cabinet-model room we step over to our latest model with some such statement as: 'Before you go, I want you to look at the latest creation of the \_\_\_\_\_ Company.' We turn the set on, explain a few of the features and ask the customer to listen for a few moments to a musical program. The great majority of the customers are interested, will stop, will listen—then will accept our offer of a chair. While they are listening to the radio, we quietly slip over and draw together the sliding doors between this room and the table-model room. We shut him away from what he has purchased.

"Then we launch an explanation of the features of

(Please turn to page 30)

# How to FIGURE

*An article of particular interest to independent servicemen and repair department managers who must "stand on their own feet"—Including a typical expense breakdown for organizations grossing \$5,000-\$10,000 annually*

By John F. Rider

IN the November issue of *Radio Retailing* the author explained why knowledge of operating costs is vital to the welfare of a radio service business. We did not insinuate that the serviceman must become a businessman at the expense of technical proficiency. The practical ability to repair a set is what enables a man to engage in servicing as a means of livelihood. Proper business administration, however, is necessary if he is to capitalize upon this ability.

Technical proficiency and business ability go hand-in-hand. Technical proficiency, for example, hinges somewhat upon profit. For only when an operation is profitable can its owner keep abreast of the art. Study costs money and requires leisure time. Neither the money nor the time will be available if the serviceman must keep his nose to the grindstone in order to make a bare living. Furthermore, his technical knowledge will be seriously handicapped if there is not sufficient profit in the till to maintain good instruments and tools.

\* \* \*

We listed in the first installment of this article (concluded in this issue) a number of items which represent costs of running a service business. Now we are ready to see how these various costs may be arrived at and how they may be used to best advantage.

The word "expense," used in place of "cost" throughout the following text, will be applied to all forms of expenditure with the exception of money spent for merchandise later re-sold to the consumer. The reason for the omission of this item will become apparent as you read further.

Expense items will be listed under two general headings. The first is "Recurrent Expenses," applied to items which re-occur at regular intervals and which are of known amount. These items are virtually fixed and with one possible exception do not vary greatly with the volume of business obtained. The one exception is rent. Higher rent encountered when the operation moves to a better location may conceivably be defrayed by resulting increase in sales. For the sake of clarity we assume an optimum value of rent, consistent with the average volume of service business.

The second expense heading is "Variable Expenses." This is applied to expenses which vary with the amount of sales promotion work done and the volume of business obtained.

## Determining Expenses

How do we go about determining the expense items "native" to any one operation? The man already in business

has some record of funds expended. He simply apportions the various items to the proper classifications.

The man just starting in business may not be able to anticipate all expenses but he can approximate at least the recurrent expenses.

For guidance we include herewith, and shall use as examples, actual items of expense found in service establishments doing a gross business of from \$5,000 to \$10,000 annually. (EDITOR'S NOTE: These figures are extremely valuable for purposes of comparison and comment concerning them will be welcomed.)

## RECURRENT EXPENSES

Item	Expense per month	Expense per year
Shop insurance .....	\$ 1.00	\$ 12.00
Car insurance .....	2.50	30.00
Rent .....	22.50	270.00
Light, heat, power .....	2.50	30.00
Garage .....	6.00	72.00
Dues .....	1.00	12.00
Subscriptions .....	.50	6.00
Service data .....	.75	9.00
Depreciation on car .....	10.50	126.00
Depreciation on tools .....	1.00	12.00
Depreciation on test instruments .....	5.00	60.00
Depreciation on tubes .....	1.00	12.00
Depreciation on fixtures .....	2.00	24.00
Salary .....	100.00	1200.00
Telephone (shop use) .....	3.00	36.00
Car license .....	1.00	12.00
Interest on investment* .....	3.00	36.00
	\$163.25	\$1,959.00

\*The investment is figured at \$900 at 4% per annum.

It is evident that some of these items represent one initial cost and you may wonder why they are listed as recurrent expenses. For example, magazine subscriptions, service data and association dues are usually paid once a year. We have divided the total by 12 and apportioned the expense by months.

Of the numerous items listed depreciation is perhaps the most confusing. Just what does depreciation mean? Why is depreciation listed as a recurrent expense?

Answering in the order in which the questions are asked, depreciation represents the decrease in value, based upon cost price per-unit-of-time, of the equipment in question. Depreciation is introduced as a result of wear and tear during the normal life of the device. Each month it is used its initial value, be it a tube, typewriter, tester, car or whatnot, is reduced by a definite amount, determined by the normal and useful life of the device.

Depreciation is included under recurrent expenses because



# Your COSTS

we firmly believe in the establishment of a "sinking fund" as a means of securing money eventually required for the replacement of the device. If any but this "piggy bank" method of storing up funds is used by small business organizations experience teaches that the funds are rarely there when badly needed. This is particularly true of concerns operating with limited capital. The existence of a mere bookkeeping record is not sufficient. "Sinking fund" money should be withdrawn from the regular bank account each month and placed in another account for safe-keeping.

Depreciation, incidentally, should be based on the actual cost of the device, not on what you assume it to be worth.

When determining depreciation on a monthly or yearly basis there are two things to consider. The first is the normal, useful life of the device. The second is the scrap, or trade-in, value of it at the end of this life. In our estimation the useful life of an analyzer or tube checker, for example, is three years. A car is good for approximately 5 years at most. If you feel that these do not check with your own experience make the necessary adjustments. We hesitate to estimate the trade-in value of the average tester at 10 per cent of its cost at the end of three years, however. Frankly, we would personally prefer to set this value at zero at the end of useful life. In the case of the car the trade-in value is, quite accurately, 10 per cent of its cost.

The depreciation of, say, a testing device, over a three year period is the difference between the original cost to you and the scrap value. Thus if "C" is the cost and "TI" the trade-in value and "n" the number of years in the useful life, the depreciation per year is  $\frac{C-TI}{n}$ . The depreciation per month is one-twelfth of this.

Thus, if a number of testing units have an aggregate value of \$200 and a trade-in value of \$20 at the end of three years is estimated the depreciation per year is \$60 and, per month, \$5. If, on the other hand, the trade-in value is assumed to be zero the depreciation is complete in three years, so that each year it is 200/3, or \$66.66 and each month \$5.56.

It should be further known that depreciation is figured only on equipment which must eventually be replaced and, further, that the cost of maintaining the equipment is *not* considered under depreciation. It must be provided for elsewhere.

Under the caption "Variable Expenses" we find the following items, again using actual figures typical of going organizations:

## VARIABLE EXPENSES

Item	Expense per month	Expense per month
1. Sales		
Circulars, stickers	\$ 3.00	\$ 36.00
Advertising	5.00	60.00
Display signs	1.50	18.00
Postage	4.00	48.00
Telephone (for sales work)	1.00	12.00
2. Maintenance		
Repairs on car	2.00	24.00
Repairs on equipment	2.00	24.00
Tires	2.00	24.00
Gas and oil	16.00	192.00
3. Shop supplies		
General	2.00	24.00
4. Credit losses	2.50	30.00
5. Miscellaneous office expense	1.00	12.00
	<u>\$42.00</u>	<u>\$504.00</u>

All of these items represent an outlay of money but the

sums vary in amount from time to time. The greater the volume of business the greater the variable expense. In addition to the items listed there are several more which constitute expense but do not involve the outlay of actual money. They are, rather, affiliated with non-productive labor. These items are:

- Repeat calls (free)
- Customer not in when man calls
- Incorrect routing and lost time

The greater the volume the greater will be the amount of such non-productive expense costs. A method of approximating them will be given in detail farther along in the text. While items a, b and c may seem trivial, be assured that they are of considerable importance and if ignored are sufficiently so to throw an otherwise well-conducted business into the red.

## Replacement Part Sales

We mentioned earlier that the cost of replacement parts later re-sold to the consumer is not included under either of the two expense itemizations. Now to explain the "why" of this omission.

Many men have been suffering from the illusion that the difference between the cost price and the sales price of replacement parts is net profit. True, it is gross profit, but net profit it most certainly is not. Many service organizations have deliberately kept their service charges low in order to get the business, believing that the net profit on replacement parts sales would be sufficient to produce a profit.

Let's see if it is.

The expenses associated with replacement parts sales certainly have some influence upon the service charges to be established. Some men may feel that such is not the case and to them we recommend close reading of the following: Expenses chargeable against replacement parts sales tend to reduce the expense chargeable against service or labor sales. If this is not fully understood and the non-productive time is charged against service sales it is apt to raise the service charge per unit of time to such a figure that business is curtailed. On the other hand, if too much faith is placed upon profit accruing from the sale of replacement parts and non-productive time ignored service charges may be so low as to render the entire operation distinctly unprofitable. Consider the following tabulation:

## REPLACEMENT PART EXPENSES

- Rent charged to replacement parts storage and display space
- Equipment purchased to house replacement parts
- Travelling time and cost securing parts from jobber
- Postage and stationery expense of securing parts
- Telegrams, telephone and similar forms of communication with in town or out of town jobbers
- Amount of insurance premium pro-rated to cover parts

Take our word for it. Inconsequential as these costs may seem at first blush they *are* of considerable importance. If this were not so we would ignore them here as it is not our wish to "clutter up" space with picayune details.

All of these items of expense whittle down the gross profit accruing from the sale of replacement parts. More about this later.

Now let's dig into the figures on the typical example shown and see how all this works out from the standpoint

of service charges. Let's assume that the man running the organization is the worker and that the whole operation is a one-man show. With but one major change, the addition of more salary, the thing checks out closely for two men or more but the one-man show is easier to discuss.

First, we have the fixed expense, shown to be \$1,959 per year under "Recurrent Expenses." This is based upon the possession of a \$700 car and \$200 worth of test equipment. If more equipment than this is owned then the expense is greater.

The average service station, operated sensibly, where the owner wishes to live like a human being, operates about 25 days a month or about 300 days a year. We assume 8 hours per day. This means a total of 2,400 working hours per year. If you work more hours jack up the figure to suit yourself.

### Information Obtainable

Now what information can we secure from this recurrent expense tabulation? Let us for a moment picture the owner of the shop as working the full 2,400 hours at the commonly quoted \$1 per hour service charge. This would provide him with a total income from labor of \$2,400 if there was no wasted time. Assuming that he did not have an additional dollar of expense he would be left with a surplus of exactly \$441 after paying recurrent expenses, which must certainly be paid. If this man converted the \$441 to his own account it would be the equivalent of about \$8.80 added to his salary, making the munificent total \$33.80.

If he charged \$1.50 per hour and worked the full 2,400 hours the total income would be \$3,600, which would provide a balance of \$1,641, or the equivalent of \$32.82 per week over and above the fixed salary. However, all of us know that few if any service stations operate at full capacity. Furthermore, a certain amount of time is lost irrespective of how one tries to avoid such loss. Certain jobs take longer to repair than has been anticipated . . . the customer is not home when the man calls . . . certain jobs are not up to par after deliver and must be done over without charge . . . tools are not handy or available for special jobs and must be put together or improvised. Service data is not on hand and time is lost checking the circuit. Considering all these factors, including time taken for a restful smoke (and no man wants to drive himself so hard that this fleeting pleasure is eliminated) we feel that if a man actually works 85 per cent of the total available time, or 2,040 hours, he is indeed diligent.

Based upon the total recurrent expenses the basic cost per hour to the station owner is 96c. Obviously a charge of \$1 per hour is out of the question. A charge of \$1.50 per hour brings in \$3,060, which is not such a great improvement for the simple reason that if income is derived as a result of work done there are to be found other expenses in addition to the recurrent ones. These are listed under "Variable Expenses." Examine these, in the tabulation printed up forward in this article.

The sum of these variable expenses and the recurrent expenses is:

\$1,959
504
<hr style="width: 50px; margin: 0 auto;"/>
\$2,463

On the basis of 2,040 productive hours per year the total expense chargeable against the sale of time is slightly more, now, than \$1.20 per hour. If the charge to the customer is \$1.50 per hour, the difference between the income from service work and the expense is about \$597 per year, or \$11.94 per week. If all obligations are met, all repairs made and the sinking fund kept intact the surplus payable to the owner as additional revenue would be this very small sum. Carrying the responsibilities of a business, his gross income per week would be \$36.94 cents, which is certainly nothing to write home about.

And, bear in mind, we have not taken into account any

unforeseen expenses. We have been very conservative with items such as car insurance. In the event of some accident to the car calling for a major repair additional expenses would have to be met.

### Setting Up A Sales Quota

Let us view this expense from another angle. Knowing the expense involved during a year we know just what billings must be for that period. We can very readily see that in order to break even, and no business can long continue to just break even, the income from the sale of time alone must be at least \$2,463 per year. If by chance the owner-worker decides that he needs \$35 a week it adds another \$120 to the total, making the expense figure \$2,583 per year. On the basis of \$1.50 per hour the income would be just barely enough to cover this draw.

And what about dull weeks or months? We know that we cannot penalize the customer for the loss of income during such periods. However, we are looking out for ourselves. Certainly no one else will. It is therefore necessary that there be a gradual increase in the bank balance so that we can have funds for operation during slack periods. In order to achieve this goal it is necessary that the income be greater than the expense, inclusive of whatever additional money, over and above the usual weekly draw, is required by the owner. This points to a minimum charge of at least \$2 per hour, which would mean a total income from time sold of \$4,080 per year. With \$2,463 of expense chargeable against time sold the difference would be \$1,617, allowing \$15 a week in addition to the weekly salary of \$25 and still leaving some money in the bank to take care of the unexpected.

### Parts Profit Insufficient

The subject is not yet completed. We realize that some men will feel that a charge of \$2 per hour is excessive in view of competition and because of possible profits upon the sale of replacement merchandise. So let's look again at replacement parts and see how they influence our business.

We know that the usual discount on replacement parts is approximately 40 per cent. This means that if the merchandise is sold to the consumer at list the gross profit on the sales price is 40 per cent. This difference between list and cost price is not all profit, as pointed out before. Certain expenses classified as "Replacement Parts Expenses" are encountered.

Suppose that the loss of time associated with replacement parts sales is recognized and added to the loss of time experienced in connection with repair work. How much time would this be? We have heard various estimates and are tempted to say that it approximates 30 minutes per day, over a period of a year. Based upon 300 working days this is about 150 hours. We feel that this is conservative.

Let us remind you at this time that these 150 hours have not been included in the amount of time lost in connection with service operations so that it would be possible to figure this time at \$1.20 per hour, or \$180 per year. Suppose that only 10 per cent of the total space used is given over to replacement parts storage and display. The portion of the rent applicable against replacement parts sales would then be \$27 per year. Naturally, this would be deductible from the total of recurrent expenses. At least we could work it that way.

Suppose we assume that telephone expenses are already included in the recurrent and variable expense lists and that there is no telegraph expense. Also that the postage expense is already included in the miscellaneous office item. What have we now?

It appears that the average replacement parts purchases of the majority of operating service establishments approximates \$100 per month, or \$1,200 per year. This is cost. The merchandise is resold at list. The gross volume is

(Please turn to page 22)



Santa Claus and  
John Chinaman  
Featured in These  
*End-of-the-Year*  
**IDEAS**



**Puts Life in the Old Man**

**B**AKER BROTHERS, Newark, N. J., procured a high box, covered it with red brick crepe paper to simulate a chimney, cut a figure of Santa Claus from a piece of display material and pasted it on stiff cardboard. A cord was run from Santa's head to the ceiling, thence to the front door.

Whenever the door was opened Santa popped out of the chimney—placed in the center of the window. When the door closed, Santa dropped down again.

**It's an Old Chinese Custom**

**I**T IS a good thing to settle up your bills at the end of December and start the New Year with a clean slate. It is equally desirable to get your customers to settle with you before the first of January.

Simpson's Radio Shack, Paterson, N. J., got excellent



results with a collection letter mailed out in December. Some of the accounts collected were long past due. Here is the letter:

"If you happened to be in China on New Year's Eve and saw a man walking around with an illuminated, red lantern, you would know that he owed debts that were unpaid because it is the custom of the Chinese to settle up all debts the last day of the year. The practice of advertising one's indebtedness with a red lantern as a sort of danger signal, may be too crude for our Occidental minds, nevertheless, we must admit that the Chinese custom of settling all debts by the end of the year is commendable and it doesn't take a red lantern to put it into effect.

"You owe us \$32.60. We also owe bills. We want to follow the good old Chinese custom and settle *our* bills by the end of the year. But before we can pay what we owe, we must collect what is owing us. Why not give us a Chinaman's chance to pay our bills by sending us a check for what you owe us to date?"

"Happy New Year.

"Sincerely,  
"SIMPSON'S RADIO SHACK"

**Santa Sells Car Sets in December**

**S**ANTA CLAUS in an open car with the top off went cruising around Red Bank, N. J., and environs with an auto radio playing in the car and a big banner on back reading: "An auto radio makes an acceptable Christmas gift." At intervals the car would be parked in front of the Miller Radio Shop, the auto radio playing the while. Another auto radio was hooked up on the sales floor and an emergency car stood on call equipped with car radio so that a prospect could be taken for a demonstration if he so desired.

When the Santa Claus car was parked in front of the store, Santa took such prospects for demonstrations. Many shoppers got a kick out of riding around town with Santa Claus.

Miller sold 23 auto radios last December.

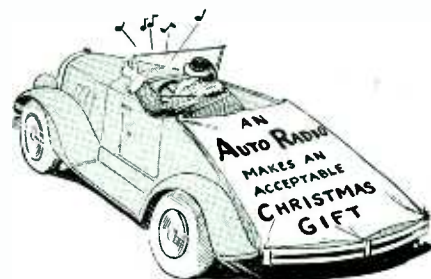

# NOW

## We Can Make

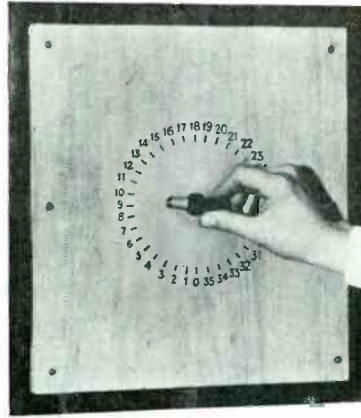

The antenna terminal of each set is connected to one of these contact points; thus any set on the floor may be instantly switched to the shielded aerial

# Store Demonstrations that Sell

*Kurtz furniture stores install multiple outlet, all-wave antenna systems—Mr. Kurtz, Jr., cites four sales advantages*

**A**FTER hearing Mr. Jacques Kurtz, Jr., enthusiastically proclaim the merits of his new all-wave store antenna system, how it pepped up sales closings and cut down selling costs, one wonders why so many dealers still persist in handicapping themselves with antiquated store demonstration methods.

Convinced that today's modern, ultra-sensitive set calls for a new demonstration and sales technique, and sensing the need for store aerial equipment that would obviate the customary apology for "local static," Mr. Kurtz, general manager for J. Kurtz & Sons, Long Island, N. Y., recently installed a noise-free, all-wave multiple-outlet antenna system in each of his four furniture stores. The set-end of the twisted trans-

mission line from the aerial terminates at the distributor arm of a 35-point circular contact switch. Every set on the floor, table and console models, is at all times properly grounded and has its aerial post permanently connected to its own feed wire running to this central switch. A "lower set unit" is, temporarily, fastened to the back of each set, in series with the aerial lead-wire. Thus the salesman, by reaching behind the receiver and throwing a little switch in this unit, can quickly throw this selector switch from low to high impedance—depending upon the meter length of the station about to be tuned in. In other words, both domestic and foreign stations can be demonstrated immediately and under as favorable conditions as will be found in the most expertly installed or ideally located home job.

"It's just plain common sense," states Mr. Kurtz. "Why under the sun any live radio man should continue with half-baked store demonstrations and the consequent expense of a second demonstration in the home—with a delayed closing, I can't understand."

### *Modern Demonstrations for Modern Receivers*

To sell today's sets—off the floor—you must have a special antenna system, according to Mr. Kurtz. Such an installation, in this instance, enables Kurtz radio salesmen to perform these four major sales objectives:

1. Demonstrate local, distant and foreign stations, devoid of electrical interferences with full tonal quality and volume.
2. Switch quickly from one set to another for comparison purposes.
3. Cut down by 70 per cent the number of home trials or demonstrations—with a very considerable saving in overhead expense.
4. Make perfect demonstrations in congested shopping areas. Inasmuch as most stores with the greatest floor traffic must be so located this is highly important.

Kurtz first tried out his new antenna system in his Jamaica store. Results were so gratifying that, within three weeks, he authorized duplicate installations for his three other establishments.

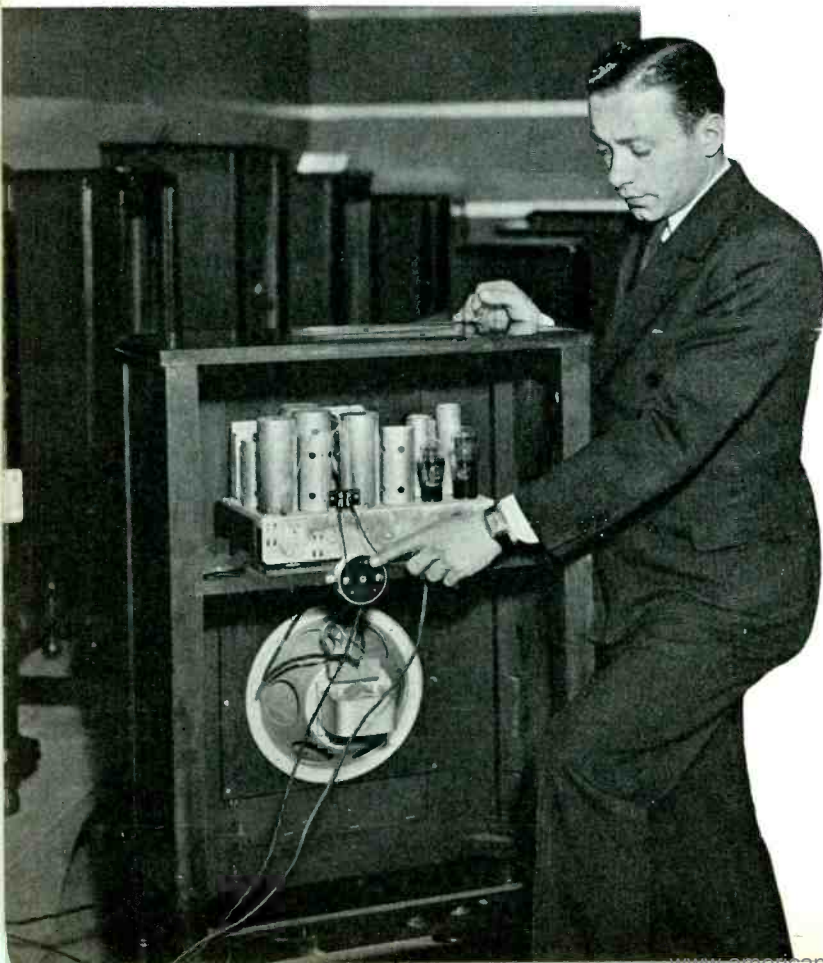



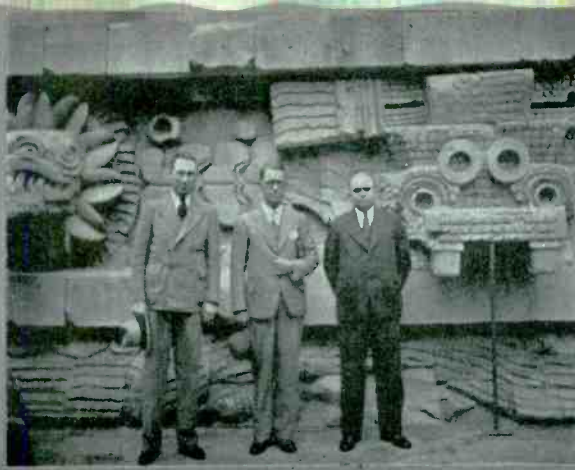

**SOUTH AMERICAN ARCHITECTURE . . . ANCIENT AND MODERN**

**COLUMBIA** *Kruse & Cia., Cali, job radio behind this impressive front*

**PRE-AZTEC** *The idol, not Mr. Jones (Norge), Gifford (Borg-Warner) or Coogan (Sylvania)*

**MEXICO** *Frank Vadillo's store, Merida, Yucatan, also reflects Aztec trends*



**FRANCE** *One reason why American concerns find this market so hard to crack open.*

## Greetings

### To Our Foreign Friends

**T**HE international exchange of programs on Armistice Day, via short-wave, supplies striking evidence that the peoples of the world are rapidly being drawn closer together. Today, thanks to the popularity of distant tuning, thousands of American set owners listen to foreign programs daily. And now American-made sets in South America, Europe, Asia, Australia and Africa are tuning in on American shortwave programs.

In its broader sense this facile medium for the interchange of ideas should do much for the cause of mutual understanding and of peace.

From the commercial aspect, shortwave has given the final impetus to the sale of American sets in a majority of foreign countries. Shortwave will further cement the pleasant and profitable business relations which have characterized the contacts between American manufacturers and their sales agents in other lands.

The entire membership of the Radio Manufacturers Association pledges a continuation of that high quality of workmanship which has made American sets so popular abroad.

LESLIE F. MUTER, *President.*  
Radio Manufacturers Association  
1317 F St., N. W., Washington, D. C.



**JAPAN** *Varco & Co. made this set. No, we didn't get the young lady's phone number.*

**SWEDEN** *Kurt Broberg write us that they distribute almost 1000 American sets annually. Now handle Zenith*

**ENGLAND** *This Colchester establishment sells 550 sets a year. "Director" Straw operates three "vans"*





# American Radio Products

## *Increasingly* POPULAR

“FROM Greenland’s icy mountains to India’s coral strands,” in the words of the old missionary hymn, they came! Over 150 replies from “Radio Retailing’s” foreign subscribers in answer to our questions on the status of United States radio products abroad—what is being sold; what is wanted.

American-made sets, tubes and parts dominate in South America and practically all of the other worthwhile markets in Europe, Asia and Africa where American sets are not entirely eliminated by tariff walls. The quality of American parts and receivers came in for much favorable comment. This, together with the competitive prices and all-wave table models, counts for the dominance which American sets enjoy.

But American manufacturers must not rest on their laurels. In many countries, the outstanding ones being Great Britain, Holland, France, Japan and Australia, local manufacture is closely approaching American standards and local concerns are tooling up for quantity production via the endless belt assembly methods. These countries are also making a determined bid for world trade. Great Britain through its vast Colonial contacts; Holland by virtue of the many patent monopolies which the Philips Company and its affiliates enjoy; France and Australia because of local laws barring foreign-made sets, and Japan, as might be supposed, on a low-price basis.

An analysis of the replies received indicates substantial buying power by most foreign agents or distributing houses. The average number of sets purchased over the past 12 months, per individual firm, was 1,240; the average number of tubes, 9,400. The estimated value, per firm, at the exporter’s purchase price was \$35,000 for sets and \$6,200 for tubes. The average unit purchase price was \$29 for sets and 66 cents for tubes.

### *Parts Market Expanding*

The market for certain types of parts seems to be an expanding one and was more frequently mentioned than that for sets. This is due to the fact that in many countries native concerns are now getting into production on sets and local laws are being passed favoring local manufacturers and making almost prohibitive the import of sets. On the other hand, the quantity requirement of many of these countries is so limited that it does not pay local firms to tool up for the manufacture on the neces-

sary quantity basis on certain types of parts. These parts, also, may be imported at much less tariff duties than the completely assembled American set.

The parts most often mentioned were: resistances, microphones, aerial kits, batteries, humidity proof power transformers (oversize), electrolytic condensers, mica and paper condensers, coils, sockets, pickups, switches, potentiometers, dynamic speakers, volume and tone controls.

Our Antwerp correspondent warns against “promiscuous” exporting—“American set concerns closing with unknown European importers. Fortunately the parts game is too technical to permit any such slaughter.”

With respect to specific specifications for complete sets, the following suggestions are typical:

FRANCE — “Superhets with 3-wave ranges. A.C., 110-220 volts.”

CHINA—“Low price, long wave sets. Efficient all-wave midgets and phonograph combinations, battery sets, humidity proof, 220 volts, 50 cycles.”

BUENOS AIRES — “American radio manufacturers must protect their foreign

business by standardizing their prices for export.”  
COLOMBIA, S. A.—“Six- to 8-tube, a.c. sets for both short and long waves.”

MEXICO — “Reliable shortwave receivers, 110-220 volts, a.c.-d.c. Not less than 6-tube sets.”

ZURICH, SWITZERLAND—“Four- to 10-tube superheterodynes, midget and ‘combination’ models for ultra, short and short and long waves. Chassis only also in good demand.”

ENGLAND—“Superhets with high reliability factor.”

KINGSTON, JAMAICA—“All-wave sets. Some with phonograph equipment.”

SPAIN—“Very selective. 15-2,000 meters. Low price.”

AFRICA—“Stress quality products.”

EASTERN COUNTRIES—“Shortwave transmission and receiving technique have made great strides in the Eastern countries. Radio now very popular in tropics.”

From the above it will be seen that the demand is for all-wave sets and that reliability and ability to get distance is highly desirable. Table models as a rule sell best, because of the price factor.

While the volume of radio products shipped to foreign climes continues to grow, America’s export trade will fall short of its full accomplishment until such time as world currencies are stabilized and equality of tariff treatments, rather than nationalistic exclusiveness, becomes the rule.

Active Foreign Accounts  
Net Purchases Average  
\$42,000 ANNUALLY.  
What the Export Market  
Wants



# ABROAD

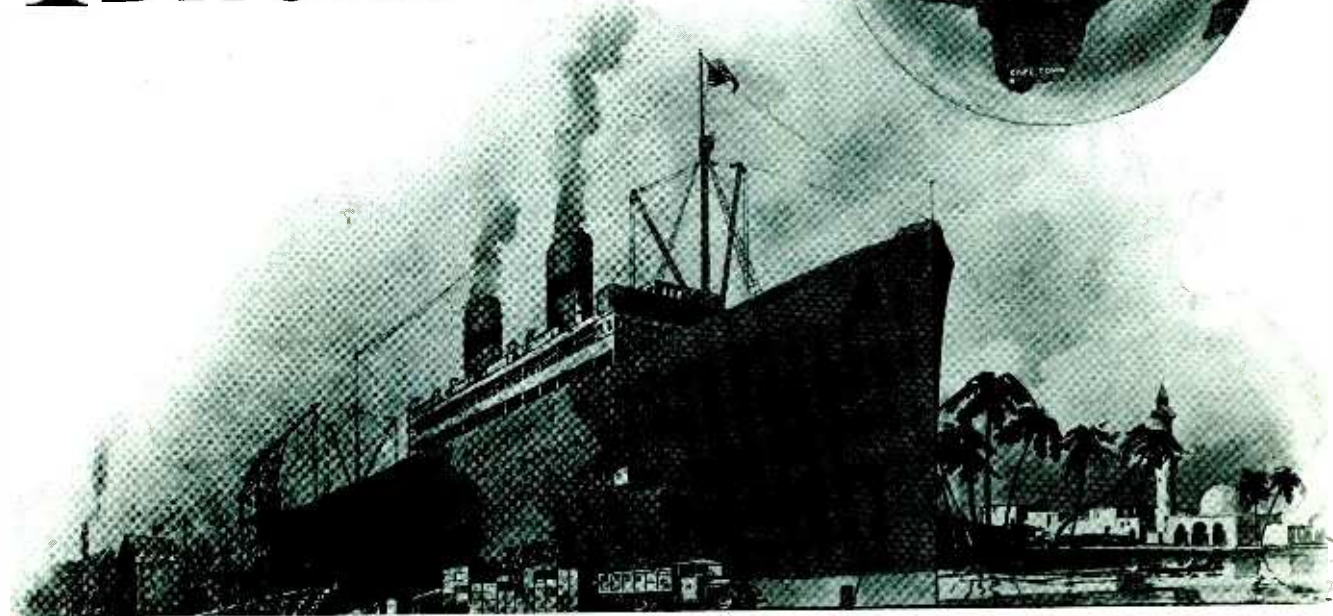

## *American Broadcasts for Foreign Listeners*

Radio merchants outside the United States will be interested in the following list of extremely high-powered American shortwave stations regularly delivering strong signals to the most distant points of the world:

Station	Location	Frequency (kc.)
W9XA	Chicago, Illinois	6080, 11830, 17780
W9XF	Downers Grove, Illinois	6100, 17780
W1XAL	Boston, Massachusetts	6040, 15250, 11790, 21460
W1XAZ	Millis, Massachusetts	9570
W3XAL	Bound Brook, New Jersey	6100, 17780
W3XL	Bound Brook, New Jersey	71310
W2XE	Wayne, New Jersey	6120, 11830, 15270
W2XAD	Schenectady, New York	15330
W2XAF	Schenectady, New York	9530
W3XAU	Newton Square, Pennsylvania	6060, 9590
W8XX	Pittsburgh, Pennsylvania	21540, 6140, 9570, 11870, 15210, 17780

Most of these shortwave stations re-transmit the regular "chain" programs serving American listeners on longer wavelengths. Thus, possession of a receiver which tunes to them (most American-made apparatus is of the allwave variety which receives stations on these shortwaves as well as the regular 550 to 1550 kc. signals) means that the foreign listener gets exactly the same superlative entertainment as the average American. Furthermore, these stations operate on one frequency or another from sunrise until 1 or 2 a.m. of the early morning hours (American time). And American programs are certainly on a par with those offered anywhere else in the world.

Amateur stations using telephone or voice transmis-

sion on the 20-meter band are likewise easily heard all over the globe, generally using higher power than do foreign amateurs. It is interesting to note in this connection that approximately half the total number of amateurs operating in the world are in the United States (approximately 30,000). Hence the foreign listener hears more Americans than the American listener hears foreigners.

American receivers of the allwave variety designed for use in the States tune from as low as 12 meters up to 500 meters. Export models are available covering this band, and, in addition, the longer wave bands necessary in some countries for complete coverage of local broadcasts. They are commonly made for either battery or all-electric operation direct from the "mains." 110 volts, 60-cycle a.c. is the most common type, but "universal" models working on either a.c. or d.c. of wide voltage range are available. Export models suitable for use in any foreign country can be supplied.

## *European Radio Cartel*

It is reported that negotiations have recently been taking place between the largest European radio equipment concerns regarding the possible formation of a European radio cartel. The concerns participating in these negotiations include the Dutch Philips concern, the Vereinigte Gluchlampen (Tunggram) of Budapest, and the German radio industry under the leadership of

Telefunken. The negotiations are concerned with the domestic turnover of the producing concerns, the regulation of prices and the control of foreign markets.

Plans call for Telefunken assuming the leadership in the German market, Tungsram in the Austrian and Hungarian markets, while Philips would dominate in the remaining markets. The share of these three concerns in the European radio production now amounts to about 75 per cent. Only English firms are lacking in this cartel, but none of them are as important as the three above concerns. It is believed that the proposed cartel is mainly directed against the American and Japanese radio industries.

## Progress In South America

By Leon de Grand Pré

"There is a great deal of activity in the radio field in South America with Argentine in the lead," according to a statement made to us by Leon de Grand Pré, manufacturers' representative, who recently arrived here from Buenos Aires.

"Argentine," continued Mr. de Grand Pré, "opened up its first broadcasting station in Buenos Aires in 1920 and it was from this station that the first broadcasting in the world of complete grand opera took place.

"Today there are 40 stations in Argentine, 15 of which are situated in the city of Buenos Aires. The power of some of these reaches 20 kw. As to the number of radio sets in the country, it is estimated that there are a half a million.

"In spite of the fact that there are several local companies engaged in the manufacture of coils, variable condensers, resistances, tubes, etc., the quantity of radio parts and sets imported from United States, Germany, Holland and other countries amounts to several million dollars per year. There is a strong preference for American merchandise, its quality being considerably superior to that of other countries. In Uruguay, Chile and Brazil radio also is highly developed."

Asked about the exchange situation, Mr. de Grand Pré replied, "Since last spring no difficulty whatsoever has been experienced in getting immediate dollar exchange for the shipments of radio sets or parts, as all the importers buy the dollars in the open market, the free rate being only 7 per cent higher than the official rate at the time of my departure in September." Closer cooperation with their foreign representatives is advocated by Mr. de Grand Pré as a means of the manufacturers increasing their business in the export field.



A Washington, D. C. dealer attracted considerable attention to his store last Christmas by advertising his wares in shorthand . . . Yes, you've got it, *shorthand*.

The ad was written in plain English script by this dealer's copy department, sent to a business college and converted into shorthand. It appeared in the papers, all except the dealer's address being in Gregg hieroglyphics.

According to the advertiser, stenographers came in by the score to comment on the copy. And many people with daughters attending business college had it deciphered, giving the ad high curiosity interest. The headline used, in plain English, was: "A Christmas Message to Busy Stenographers."

## How to Figure Your Costs

(Continued from page 16)

therefore \$2,000 with a gross profit of \$800. But do we earn a profit of \$800? Not if we consider expenses related to the sale of this merchandise. If we deduct the value of the time and rent, profit is only \$593. We predicated service charges upon a certain number of productive working hours, which quantity is reduced by the 150 hours lost in connection with replacement parts purchases. In order to play safe it is best not to deduct this amount, 150 hours, from service work, because if we do and still desire to have the income previously mentioned we would have to compensate for the reduction in available time, with the possibility that the service charge would be raised beyond reason. Hence it is best to deduct the valuation of that time from the profits on replacement parts sales.

The portion of the rent applicable to replacement parts sales is an important part of the volume of profit, but effects the cost per hour of service time only about 2c. so we can ignore it here.

It now becomes important to determine the value of the net profit remaining on the sale of replacement parts. Should this net profit influence the charge made for service or labor? We can ask this question because we have an idea of our expenses associated with the sale of time. The man who does not know his operating costs would be tempted to say "yes" and cut his service charges accordingly. Based upon an average number of calls per year, 1,000, the cost of merchandise required is \$1.20 and this merchandise is sold for \$2, leaving a gross profit of 80c. However, this average number of calls also means that the time spent in one way or another in connection with that job amounts to two hours. If the charge is \$1.50 per hour and the man requires an income of \$35 per week he will be left at the end of the year with nothing more than the profit upon the sale of the parts, which would be \$593. Is this worthwhile? We leave it to you to be the judge.

On the other hand, if the charges made for service work were such as to earn a surplus over and above the weekly income requirements of the owner-operator and the profits on replacement parts were considered extra a reasonably profitable business would be the result.

### Export Sales Show 74 Per Cent Increase

Following are the comparative figures, compiled by the U. S. Department of Commerce, of sales of American radio products abroad from January to October, inclusive, for 1933 and 1934. Total value shows an increase of 74 per cent.

YEAR	SETS		TUBES		PARTS Value	TOTAL Value
	No.	Value	No.	Value		
1933	352,332	\$6,249,000	3,946,780	\$1,887,256	\$2,684,194	\$10,820,450
1934	474,700	\$11,787,000	5,595,540	\$2,738,590	\$4,279,983	\$18,805,573
Increase	122,368	\$5,538,000	1,648,760	\$851,334	\$1,595,789	\$7,985,123



# LOCAL LOGS BRING LIVE LEADS

Specially printed logs and trick layouts for quick tuning rank this year among the best business producers. Like sponsored air time for the set maker, the radio log is a "natural" for the radio dealer. Here are four variations of this idea.

## Elliott-Zimmerman Radio Laboratory

Tubes Tested Free by Experts

Dependable Sales Service Installation Guarantee

**RADIO**  
Service - Engineering

Specializing in a guaranteed service on all makes of radios. All repairing is done by men backed by many years of experience in the engineering, manufacturing and servicing fields.

137 W. Main Street  
Alhambra, Calif.

Telephone:  
Alhambra 1804

Elliott-Zimmerman's radio log is semi-circular affair of generous proportions, thus providing space for ones pet stations to be added in ink. On the reverse is a list of 96 U. S. stations and the key foreign short wave senders. "Where and When to Tune" gives valuable instructions for bringing in the foreigners.

**PHONO STROBOSCOPE**

The figures in the rings indicate the speed of the revolving turntable when the light, in ring appears to be stationary

DEALER AND REPRESENTATIVE  
GENERAL RADIO SERVICE  
424 2<sup>nd</sup> AVE. S.D.  
MINNEAPOLIS  
MA 5073

LEFT  
General Radio Service, Minneapolis, runs "come-on" lures on the back of this envelope stuffer. They read: "FREE ADVICE—any make radio." "TIME SERVICE—Arlington time via shortwave. Tel. Maine 5673." "If you wish to buy OR SELL a radio let us know. We may know just the right party." "We can bring your radio UP TO DATE by installing the latest technical features."

RIGHT  
Hulbert Radio Electric Co., Eagle Rock, Calif., kills two birds with this one stone. On one side is listed all the easy tuning range stations. Also *News of the Hour* programs and where to find them. The side illustrated tells customers how to check their own set—which action frequently leads to a call for an expert. Hulbert uses its log as a "foot-in-the-door" stopper for its salesmen.

Here's a dial printed on celluloid. "The added impressiveness more than justifies the cost," writes A. O. Green, radio merchant at 1607 Portage Street, Kalamazoo, Michigan. Mr. Green has had his dial copyrighted but will be glad to tell other dealers about it and let them use it if they write him first. Features: An alphabetic listing of "within range" stations; stars denote NBC chain, circles indicate Columbia networks. Thus, if a program fades on one station, the listener knows where to turn to get it on another station on same chain.

## How to Service Your Own Radio

One of the commonest radio troubles is "so called" noise or static. This is caused usually from one of two sources:

- (1) MAN MADE STATIC OR ATMOSPHERIC STATIC.
- (2) OR NOISE WITHIN THE RADIO ITSELF.

One of the easiest ways to determine whether it is outside noise or radio noise, due to defective tubes or parts, is to tune in a station at normal volume and then disconnect the aerial wire at the radio. If the noise stops or diminishes materially, you can be quite sure the noise is outside of the radio. IF THE NOISE CONTINUES WITH THE AERIAL DISCONNECTED, CALL YOUR RADIO TECHNICIAN FOR A COMPLETE CHECK OF YOUR RADIO. No charge.

If your radio plays intermittently, the trouble may be caused by a bad tube. Look at all tubes. If one burns brightly and then dims or goes out, bring it to Hulberts for a test. No charge.

If your radio is weak on local or semi-distant stations, this may be caused by weak tubes—have Hulberts test them for you. If your set is turned on and no tubes light—possibly a bad fuse. Have a thorough check made for the cause of fuse blowing out—saving expensive repair later to power pack and condensers. No charge for testing.

If all your tubes light and radio does not play—check your aerial and ground connections or you may have a bad tube or defective parts in your radio. Hulberts can locate such trouble quickly for you.

When removing or replacing tubes, be sure your radio is turned off. Tubes are often damaged or destroyed by plugging in wrong sockets. Be sure they are always put back in the correct socket.

Have Hulberts test your tubes twice a year—replace them once a year and hear the difference. We test tubes free.

Remember your radio is no better than its aerial and ground connections. Do not expect to get distant reception with a poorly constructed aerial. If in doubt, call Hulberts for service or advice. Free service if brought to our store.

POSITIVE  
ACCURATE  
TESTS BY  
PRECISION  
INSTRUMENTS



THE MOST  
UP-TO-DATE  
RADIO  
LABORATORY  
IN LOS  
ANGELES

NEW HULBERT RADIO TEST PANEL  
DETECTS SOURCE OF TROUBLE INSTANTLY

FREE If you are having trouble with your radio, we will call at your home, make a thorough test of the set and give you an estimate of the needed repairs WITHOUT COST OR OBLIGATION. We have one of the most complete and up-to-date radio laboratories in Los Angeles. Nothing but the finest materials used! All work guaranteed at new reduced prices! We service everything electrical.

**JUST CALL ALBANY 4506**  
HULBERT RADIO ELECTRIC COMPANY  
5048 EAGLE ROCK BOULEVARD • LOS ANGELES, CALIFORNIA  
PHILCO RADIOS AND KELVINATOR REFRIGERATORS



# NOISE ELIMINATION DRIVE STARTED BY RADIO MANUFACTURERS ASSOC.

The interference campaign of the Radio Manufacturers Association, recently authorized by its board of directors, to improve radio reception and public satisfaction with radio programs and sets, was launched Nov. 14 at Rochester during the semi-annual convention of the Institute of Radio Engineers. Every national and some international radio organizations are being invited to join an RMA committee which will work to reduce electrical interference with radio reception in all fields.

Organization of the committee was arranged at the RMA "electrical interference" conference at Rochester by Dr. W. R. G. Baker, director of the RMA Engineering Committee. Dr. Alfred Goldsmith accepted the chairmanship of the new committee.

About 250 leading radio engineers and executives attended this convention. Drs. Baker and Goldsmith detailed the working plans of the steering committee. Addresses by Dr. C. B. Jolliffe, chief engineer of the Federal Communications Commission; Dr. J. H. Dellinger, of the U. S. Bureau of Standards; President Leslie F. Muter of the RMA; H. O. Meriman, director of the Canadian Government radio activities; O. H. Caldwell, editor of *Radio Retailing*; J. O'R. Coleman, Edison Electrical Institute and Benjamin Gross, for the Radio Wholesalers Association.

Reducing electrical interference will increase public satisfaction with radio reception and programs, thus increasing sales, also clearing electrical interference from channels which are available for facsimile and television broadcasting when developed.

## Rabsons Opens Record Store

Because of the rapid growth of its phonograph record business, Rabsons, New York, has opened a store at 1365 Sixth Avenue, which will be devoted almost exclusively to the sale of records and combination instruments. Sophie Rabinowitz will be in command of this new enterprise.



## 70 Miles on a Gallon

Ten of these Crosley Junior motor racers will speed sales of Crosley radios throughout the United States for the Christmas season. They will be awarded to the ten boys and girls who sell the most Crosley radios. In addition, a five per cent commission is being paid by dealers to all participants. These cars are real automobiles, powered by Briggs & Stratton 4-cycle gasoline engines, with a speed range of 5 to 25 miles an hour.

## Solution for Radio Interference in "Golden Rule" States Dr. Caldwell

"Although written nineteen centuries before the first radio wave winged its way through the ether, the Golden Rule offers today the best general solution to the knotty problem of radio interference," declared Dr. Orestes H. Caldwell, editor of *Radio Retailing*, speaking before the Institute of Radio Engineers at Rochester, N. Y., Nov. 14.

Opening the first national conference on radio interference elimination, Dr. Caldwell gave five simple rules for the radio listener to use, to reduce radio interference for himself and others. These rules are:

I Do unto others (in eliminating interference causes) as you would have others do unto you.

II Get your antenna for broadcast reception as high and as far away from house electrical apparatus as possible.

III In purchasing electrical appliances, automotive devices, etc., specify that they are to be of types that "produce no radio interference."

IV See that your radio tubes are new and in good condition.

V Have a competent radio or electrical

man shield or equip with choke coils or condensers, any apparatus which may be causing radio interference for yourself or others.

"The present wide interest in short-wave radio has brought new interference factors into the radio picture, due to the short-wave emissions of the ignition systems of automobiles and airplanes. The steady 'rat-a-tat-tat' of the spark distributors can often be heard for several miles, blotting out faint radio signals from across the ocean or the other side of the world. Proper shielding will largely eliminate such automotive-ignition interference. It is hoped to get the automobile manufacturers to thoroughly shield the new 1935 car models," Dr. Caldwell concluded.



## Action Window Plus

Cooperating with a group of parts manufacturers who are sponsoring an all-wave receiver kit, the Newark Electric Co., Chicago, put one of its servicemen to work in this window to show how simply and quickly this "All Star" receiver may be assembled.

An ideal combination of window attention value plus efficient use of a serviceman's time

## Copeland, Trupar and Zerozone Consolidate

A consolidation of manufacturing facilities of three concerns manufacturing refrigerators, commercial condensing units and air conditioning equipment is announced by Dallas E. Winslow, president of Dallas E. Winslow, Inc., parent corporation of Copeland Refrigeration Corp., Mt. Clemens, Mich. The other two concerns who will combine their resources with Copeland are the Trupar Mfg. Co., Dayton, Ohio, and Zerozone Refrigeration Corp., Chicago.

The production facilities of these three units will be housed in a Detroit manufacturing plant formerly used by the Lincoln Motor Car Co.

## Rider Manuals Available

National Union Radio Corporation announces that arrangements have been concluded which will make it possible for every service dealer in the United States to become the owner of a set of the famous Radio Service Manuals, compiled by John F. Rider. The National Union offers service dealers to obtain any of the volumes from one to five or all of them on a special tube purchasing agreement. This offer expires Dec. 31.



## GE ANNOUNCES NEW SALES EXECUTIVE ORGANIZATION



**J. A. PROCTOR**  
*Assistant to vice-president Wilson*



**R. J. CORDINER**  
*In general charge of sales development*



**B. C. BOWE**  
*Manager of radio sales*

Following the recent statement that General Electric's radio sets will be manufactured at its Bridgeport, Conn., works, beginning with the new line to be introduced in the late summer of 1935, comes the announcement of the executives who are to direct this new manufacturing and merchandising program.

J. A. Proctor will have the responsibility of assisting vice-president C. E. Wilson in the general coordination of radio engineering, manufacturing and sales activities. Mr. Proctor is widely known in the radio industry and takes to the General Electric Company a wealth of experience not only in radio manufacturing and design but in merchandising.

R. J. Cordiner, formerly manager of the heating-device sales section at Bridgeport, has been appointed assistant manager of appliance sales in general charge of sales development for G-E radios. Mr. Cordiner has spent more than 15 years with the

Edison General Electric Appliance Company and the General Electric Company in various key merchandising positions.

B. C. Bowe will continue as manager of sales in the radio sales section, a position he has held ever since the section was established in 1930.

The general administration of the radio department will be in the hands of a radio management committee of three, with R. J. Cordiner as chairman.

Commenting on the new line, Mr. Wilson said: "While the production now getting under way will be the line introduced in the late summer of 1935, we will in the interim continue to keep General Electric radio dealers out in the front with merchandise designed to meet all anticipated market requirements. New models will be added to the present outstanding line from time to time as dictated by dealer demand, and there will be no lapse in our radio sales program.

## Wesley M. Angle Elected President of Stromberg-Carlson

### George A. Scoville Becomes General Manager

Stromberg-Carlson directors, last month, elected Wesley M. Angle as president and George A. Scoville vice-president and general manager, to take over the duties of W. Roy McCanne, former president of the company, who died Nov. 5.

Lee McCanne will take his father's place on the board and was named secretary, and Walter L. Todd, president of the Todd Company, was elected to the directorate.

The men now advanced to more responsible positions have been with the company many years and are part of a group of executives which Mr. McCanne built up during his years at the head of the Stromberg-Carlson Company.

Mr. Angle, the new president, entered the employ of the Stromberg-Carlson Company immediately after graduation from Harvard in 1903.

Mr. Scoville, who as general manager will have supervision of sales, advertising, engineering and production, has



W. M. ANGLE



G. A. SCOVILLE

## Crosley Dealers Launch Two Advertising Campaigns

Anticipating the largest Christmas season for radios since 1928, the Crosley Radio Corporation announces two cooperative newspaper advertising campaigns to be run simultaneously by its dealers throughout the United States. One campaign is devoted especially to Christmas advertising for both radios and refrigerators. The other is straight radio advertising which uses cartoons and humorous appeals. It is estimated that the amount to be spent on the two campaigns will total \$200,000.

## Philco Service Manager Explains RMS

To the Editor, *Radio Retailing*:

"Radio Manufacturers Service now has approximately 12,000 members. Among these members are men who do not handle Philco. The benefits they receive are not influenced by whether they are customers or not. The purpose of the organization is to make more service jobs and more profit for servicemen. If the service industry is improved it will help us sell more sets.

"We are supplying members with binders containing wiring diagrams of all our models up to January, 1934, service bulletins on sets produced from January, 1934, to date and service lesson sheets. We have distributed over 125,000 of the latter. Our service house-organ also reaches 27,256 circulation each month.

"We are spending a tremendous amount of money for the benefit of radio service men. Advertising of all kinds (news-papers, magazines, handbills, direct-mail, broadsides and broadcasting) is being used; does not cost service men a cent.

"We are willing and eager to cooperate with any plan which is in the interests of service men, whether this plan calls for cooperation with magazines, with other service organizations or with other radio manufacturers."

ROBERT F. HERR, *Manager Parts and Service Division Philco Radio & Television Corp.*

## Curtis Moves to Larger Quarters

The Curtis Condenser Corp., manufacturer of electrolytic condensers, has moved its factory into larger quarters at 3088 W. 106th St., Cleveland, Ohio. Curtis was unable in former limited space to keep production abreast of orders.

been associated with the telephone industry since 1903, when he completed the electrical engineering course at Stanford University and entered the shop of Western Electric Company.

Lee McCanne, the new secretary, was graduated from Massachusetts Institute of Technology in 1929 and since that time has been associated with Stromberg-Carlson, having occupied positions in both the engineering and sales departments. Recently he has been engaged in sound system promotion work and he will continue while acting as secretary to be responsible for a large share of the company's development.

Due to the rearrangement of work, additional responsibilities will be carried by Edward A. Hanover, vice-president in charge of production and Dr. Ray H. Manson, vice-president in charge of engineering.

## A-K Program Rates High

Atwater Kent's new radio program, heard Monday nights at 8:30 over the CBS nationwide network, has been voted by the Radio Editors' Board of Review as the outstanding radio program broadcast nationally during November.

# RADIO NOTES from OTHER LANDS

*The following items have been compiled from information received from the U. S. Department of Commerce, from foreign readers of Radio Retailing and other sources.*

American radio manufacturers dominate the **Peruvian** market. Improvement in radio sales largely the result of a prosperous cotton industry and the favorable exchange.

**Japan Self-Sufficient**—"We can produce almost any kind of radio sets and parts cheaper than in America and we are exporting a large quantity of them to Australia, China, Africa, India and South America. Radio sets and parts are taxed 40 per cent." Tanabe Shoten, Tokyo.

**Russia** becomes number 84 and French Indo-China, 85, in the list of countries in which Hygrade-Sylvania is regularly selling tubes, according to W. A. Coogan, manager of foreign sales. Among recent guests at the Sylvania Club, Emporium, Pa., have been sales representatives from Spain, France, Mexico, Chile, Greece, Russia and South Africa.

"Owing to high **Italian** customs house rates we are not in a position to import American products," writes Angelo Alati from Rome. Mr. Alati is correct. Italy is not a prime market for U.S.A. radio goods.

This condition also applies to **Austria**, according to our correspondent, Czeija Nissel & Co.

In **Central and South America** demand for American radio sets, tubes and parts is stronger than ever. Witness the following reports:

**Mexico**—Improved economic conditions and better radio programs have resulted in substantially expanding the market for radio receiving sets. Imports of radio sets into the Republic in 1933 registered a 70 per cent increase over the preceding year. During the first half of the current year U. S. exports of radio sets to Mexico amounted to 17,445 units, against 15,347 units for the corresponding period of 1933. American manufacturers hold a predominant position in the Mexican market, supplying in 1933 over 99 per cent of total sets imported.

**Brazil** buys 95 per cent of her imported radio receivers from the "States." Demand steadily increasing—"but so is competition among American distributors." Table type sets predominate.

**Argentina** has 39 broadcasting stations. Approximately 500,000 sets in use. During the past 18 months the importation and consumption of radios and radio equipment in Argentina has shown marked increases, even in the face of world-wide conditions which have been severely felt in this country in other classes of imports.

Radio development in **Ecuador** is still backward in comparison with the majority of other South American coun-

tries, but the Government and many radio enthusiasts are promoting its progress, and it is expected that in the near future Ecuador will become a limited but fair market for radio equipment.

American sets enjoy an enviable reputation for quality. They are extremely popular with the **Chilean** listener and American shortwave sets have been very well received and are becoming ever more in demand.

The superior performance of American-made radio receiving sets have acquired for them a high standing in **Rumania**.

The growing interest in radio broadcasting in **India** has stimulated the demand for American receiving sets in that market, according to Trade Commissioner George C. Howard, Calcutta. New, shortwave "Empire" programs a big factor.

While domestic sales have continued to increase, **Germany's** foreign radio business has declined slightly. German radio dealers do not look for any great improvement in their imports of radio products in the future. They believe, however, that domestic sales will continue to rise and they anticipate that 1935 will prove a record year for the German industry.

**French** manufacturers now feel that they can compete in price value and technically with any foreign set and are getting a better grasp on their own market. They believe that the sets built in France are more selective than those imported.

Imported American sets have sold very well, although profits are not as large as in previous years. At the present time 60 per cent of the sets sold in France are of foreign make and approximately 40 per cent of these are American.

While the opportunities for the sale of completely assembled American-made receivers in **Australia** and **New Zealand** is now extremely limited, due to high tariff restrictions, there remains a worthwhile market for American parts, such

as vibrator type rectifiers, fixed condensers and resistors, etc., according to R. Burke, chief engineer of the Radio Corp. Pty., Ltd., Melbourne, who visited *Radio Retailing's* offices last month.

The United States is the chief supplier of sets to the **Egyptian** market; accounts for 60 per cent of imports. Apprehension of Japanese competition not confirmed by actual sales results.

Receiving licenses indicate that there are slightly more than 500,000 sets in use in **Denmark**. The ratio per 1,000 population is 130 sets, the highest in the world. American sets find but limited sale in this market, owing mainly to prices in normal times. Depreciated exchange has considerably increased this effect. Import permits are also required.

**Norway** continues to be a promising market for American radio sets adapted to European wave lengths of from 200 to 2,000 meters.

Indications are that **South Africa** may be classed as one of the leading radio markets of the world, considering population and economic conditions. The comparative isolation of this area from other countries of high development and large population, create a special interest in radio as a means of social contact. The improvement of facilities for interchange of program, either by means of short waves or rebroadcasting, especially with England, intensifies the peculiar interest in broadcasting that exists in South Africa. The market is, however, highly competitive.

The **British Radio Manufacturers' Association** has been active for several years in developing expedients by which foreign goods may be excluded from competition in the British market, especially through pressure upon wholesalers and retailers. Several plans have been tried, employing both punitive measures against dealers in foreign goods through restricting their supplies of British products, and by rewarding dealers in British goods exclusively through added discounts.

That **Persia** may be developed as an outlet for American radio sets is pointed out in a report from Vice Consul R. A. Hare, Teheran, made recently.

Increased activity in **Czechoslovakia's** radio industry during the current year has been reflected in declining imports of receiving sets and parts.

The **Canadian** radio industry is benefitting by the improved economic conditions prevailing in the Dominion. Reports of the Radio Manufacturers Association of Canada show that unit sales during September increased by nearly 100 per cent over August, while list values advanced approximately 150 per cent. Demand for selective sets doubled in September and 2,215 allwave consoles were sold.

It now appears that plans of European radio receiver manufacturers, particularly Philips (Holland) and Telefunken (Germany), are being crystallized

## "Down Under"



A. E. Bennett, managing director of Station 2GB, Sydney, who has been elected president of the Australian Federation of Broadcasting Stations



to a point whereby they will be able to dominate the Swedish market to such an extent that American radio receivers and tubes will have little chance of being sold in Sweden.

The necessary apparatus to adapt American sets, of which a large number are in use in Switzerland, to Swiss conditions, is easily available commercially. The only disadvantage of American sets is their limited wavelength range, whereas for complete European service, the range must be extended to 2,000 meters. On the other hand, American sets are marketed at lower prices and the tubes are exceedingly cheap, compared with European tubes, and they are, as a rule, better in every respect.

**Belgium Sales Curtailed**—High import duties and improvement in quality of locally-produced sets have brought about a marked decline in imports of American radios. American parts, however, are more popular than ever. Antwerp's first radio show a success. Only one American set shown however.

The Australian Radio Manufacturers Patents Association has been formed to conserve the interests of manufacturers in respect of patent royalties. The association announces the intention also of acquiring patent rights direct from patentees as opportunity occurs.

The formation of this association follows upon the disbandment of Radio Interests, Ltd. The latter was formed a year ago when the Commonwealth Government decided to cease paying to Amalgamated Wireless 3s. a year out of every listener's license of 24s. In return for such payment Amalgamated Wireless permitted the use by every manufacturer of all its patents, including those of the Marconi Company of England.

The Australian Manufacturers Patents Association embraces makers of receivers and radio components, starting, it is stated, with 30 foundation members in Sydney, Melbourne and Adelaide.

## Garod Engineer Departs for England on Trade Tour

Kenneth Harkness, of the engineering department of the Garod Radio Corp., New York, has sailed for England on a brief trip to the British and western European radio trade. Mr. Harkness plans to submit some of the newest Garod models to actual performance tests under European broadcasting conditions. He will also spend some time visiting various accounts of the firm, many of whose officials are personal friends of Mr. Steiner, export manager of the Garod organization.

It was revealed that the Garod Radio Corp. has been appointed a licensee of the Hazeltine and Latour corporations.

## To Increase Export Markets

Efforts to increase foreign markets are being made by the Radio Manufacturers Association in behalf of the radio industry in connection with present negotiation of new reciprocal treaties with many foreign countries.



## Buenos Aires Radio Magnet

*Samuel A. Gomez owns his own business. Last year he sold to South American radio dealers over a quarter of a million U. S. tubes. Is in the market for American made parts and accessories. A typical high class exporter.*

## International GE Wants Small Countries Representation

Writes J. A. Streibert, of the International General Electric Co., Schenectady, N. Y., U. S. A.:

"While we now have distributors in 53 overseas territories, there still remain a few of the smaller countries where we have not arranged radio distribution. We are interested solely in complete receivers.

"Your experience is quite correct that there is a great interest among the foreign merchants in American radio products just now. That American receivers are in demand overseas is well shown by the fact that U.S.A. exports for the first six months of 1934 exceed \$7,000,000, as compared with something over \$9,000,000 for the 12 months of 1933. Our GE export sales of radio receivers for 1934 will easily be double our 1933 sales."

## 43,000,000 Sets, World Total

According to the U. S. Department of Commerce there is now a World total of 42,512,000 radio receivers in more or less active service. These are divided as follows:

North America .....	19,770,000
South America .....	910,000
Europe .....	18,570,000
Asia .....	2,530,000
Africa .....	93,000
Oceania .....	639,000

Number of broadcasting stations are placed at 1,630.

## Enlarge Kingston Export Dept.

The export department of the Kingston Radio Co. has been established in larger offices at 320 S. Wells St., Chicago, according to H. J. Scheel, export manager. Mr. Scheel was formerly export manager for Majestic. Wants foreign accounts.

## Expansion of Foreign Trade Urged by U. S. Business Men

Expansion of foreign trade rather than a policy of economic isolation was advocated by a majority of public officials, business men, economists and journalists who appeared before the Commission of Inquiry on National Policy in International Economic Relations at hearings in eight American cities, Nov. 14.

Summing up the predominant opinion in their testimony, the commission said:

"The American public has been disillusioned in its traditional faith in a high protective tariff as a guarantor of prosperity and has acquired a profound skepticism of the emergency measures designed to raise income by restricting output. Strong protectionist support, however, was voiced in each section of the country, even in the South, not only by individuals representing domestic manufacturing interests in different sections, but also with one exception by the various representatives of labor.

"Many of those who addressed the commission spoke in favor of international monetary stability. The gold standard had more adherents than the commodity dollar, while greenbacks found but one lone supporter. The majority of those who expressed themselves on the question of war debts favored cancellation. Postponement, or exchanging war debts for trade concessions was also advocated."

## Crosley Distributor from Palestine Visits Factory

David Levinson, of Tel-aviv, Crosley distributor for Palestine, was a visitor at the factory in Cincinnati, recently. Mr. Levinson arrived from Chicago via airplane.

Tel-aviv is the new city in Palestine built on the plans of a modern American city. A new Palestine has replaced the old because of the large number of Jews from the U. S. and Germany who have moved there, Mr. Levinson stated.

For these reasons he reports a big improvement in the radio business and great popularity for short and all-wave sets.

## Kraus Gets Another Account

The Barton Washing Machine Co., of West Bend, Wis., announces the appointment of H. L. Kraus, Inc., 330 W. 42nd Street, New York City as its export agent.

Kraus is now handling the export sales of the Electrical Research Laboratories, Inc., and the Standard Transformer Company, both of Chicago.

## G-E "Live Wires" Sell Seven Times More

"What makes a good radio merchant?" General Electric recently conducted a field survey to find out. Found that 10 per cent of its dealers were turning in one-half the total volume. Found further that practically every "volume" retailer used "dealer helps" avidly. Those using special sales methods, publicity and displays sold approximately seven times more radio goods than those who did not.

# NEW MERCHANDISE



Fada Model 1452F

## New Fada Line

The first announcement on the new line of the re-organized Fada and Electric Co., Long Island City, N. Y., has just reached this office.

There are eight models—three table sets and five consoles.

Model 1462D is a 6 tube a.c.-d.c. "low" table set covering the broadcast band and 5.8-15.5 mc. \$43.95.

Model 1452A is a 5 tube a.c. job and covers the same bands. \$43.95. As Model 1450A, a.c.-d.c., in a similar cabinet, the price is the same.

Model 1480C is a deluxe 8 tube a.c.-d.c. superhet. in an upright table cabinet designed along conservative modernistic lines. Tuning range: 550-1500 kc. and 5.4-15.5 mc. \$64.50.

Model 1470E is a 4-band console radio using 7 tubes. Tuning range: 525 kc. to 23.75 mc. The speaker is a 12 in. dynamic. \$99.95. The Model 1480C, 8 tube a.c.-d.c. chassis may also be had in this cabinet.

Model 1452F is a 5 tube a.c. console which will bring in the regular broadcast band programs as well as those heard in the 5.8-15.5 mc. zone. \$62.50. Model 1450F, 5 tube a.c.-d.c. chassis may also be had in this cabinet.

All Fada sets have the large airplane type dial and the table sets are equipped with phonograph jack. Any model mentioned may be had to tune up to 2,000 meters at small additional cost.—*Radio Retailing*, December, 1934.

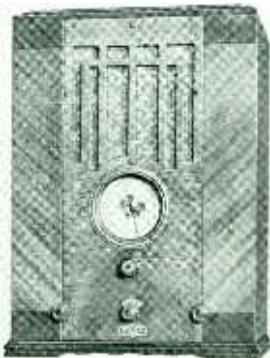

Fada Model 1480C

## Philco Model 66L

For the Christmas season, the Philco Radio and Television Corp., Philadelphia, Pa., is introducing a traffic-getter in its Model 66L. This set incorporates the 66 all-wave chassis in the 45L cabinet. \$49.95.—*Radio Retailing*, December, 1934.

## Zenith "Stratosphere" 25 Tube Set

Using 25 tubes and three speakers, the "Stratosphere" console of the Zenith Radio Corp., 3620 Iron St., Chicago, Ill., will carry a list price of \$750.

To get right into the technical details, the tube line up consists of 6-6D6's, one each for first and second r.f., first and second i.f., shadow tuning meter and a.v.c. amplifier; a 76 second detector and 2-76's for parallel first audio stage; a 79 relay for "Q" circuit; 8-45's in the push-pull parallel output power stage; 6A7 first detector oscillator; 85 for a.v.c.; 2-42's in the push-pull second audio stage and 3-5Z3's as rectifiers.

Two concert loud speakers handle the high power available on the low frequency response and a small high frequency dynamic speaker handles the high frequencies above 3,000 cycles. The large speakers are mounted behind the baffle board and



American Bosch Model 430J

## American Bosch Models 430 J and 430 T

Two important additions to its line of "Round the World" radios are announced by the United American Bosch Corp., Springfield, Mass.

These sets are Model 430J, a console listing at \$59.95 and model 430T, a console at \$44.95. Both have a triple range—540 to 1,700 kc., 1,700 to 2,400 kc. and 5,800 to 18,000 kc.

They are five tube superheterodynes with "Line-O-Lite" tuning and new simplified type, illuminated, three-band calibrated dial.—*Radio Retailing*, December, 1934.

## Emerson Model 19 and 100

A small a.c.-d.c. superheterodyne at a low price is being marketed by the Emerson Radio & Phonograph Corp., 111 Eighth Avenue, New York City. Known as Model 19, it is housed in an attractive brown mahogany, mottled Bakelite cabinet. The price is \$19.95. Emerson's "make-good" offer, introduced on its recent Model 32, applies also to Model 19.

Model 100, all-wave console, \$99.50, is a 7-tube superheterodyne with world-wide range, 15-550 meters. This set has the "signal filter" to clarify the program and "Quadro-Lite" band switching circuit. The lowboy cabinet is conservatively modernistic in design.—*Radio Retailing*, December, 1934.



Emerson Model 19

the smaller speaker has a horn to distribute the sound more evenly throughout the room.

There are two chassis. The top chassis contains all the r.f. and i.f. circuits, the audio circuits except the power output stage, a.v.c. and "Q" circuits and special audio compensation circuits. The other chassis (at the bottom) contains the output power stage and two complete separate power supply circuits.

There is a high fidelity control on the panel which mechanically changes the coupling in the i.f. transformers. When this coupling is at minimum the receiver is very selective; when the coupling is at maximum it is broadened out to where it will handle the 8,000 cycle modulations.

The "Stratosphere" covers five bands, each wave band being individually lighted on the extra large airplane dial, as it comes into use. These five bands are: 535-1,550, 1,530-4,575, 3,725-11,150, 9,500-31,600 and 19,500-63,600 kc.

The cabinet is a symphony in rare woods blended for harmony and color. Design has been dictated by the basic principles of acoustics.—*Radio Retailing*, December, 1934.

## "Serv-U-Fone" Private Phone System

Designed for intercommunicating purposes in home or factory, the low-priced "Serv-U-Fone" system of the American Automatic Electric Sales Co., 1033 W. Van Buren St., Chicago, can be sold where elaborate and expensive telephone equipment is not justified. This system may be had in both the desk and wall types handling from two to eight stations. Each phone is labelled and no soldered joints are required so that the services of a technical electrician are not necessary for installation.—*Radio Retailing*, December, 1934.

## Atwater-Kent Model 318-C

An 8-tube all-wave superheterodyne with nine tuned circuits is now ready says an announcement from the Atwater Kent Mfg. Co., Philadelphia, Pa. This set covers from 540 kc. to 22.5 mc. It has 11-in. improved dynamic speaker and automatic switch for doublet and single antenna. It is a lowboy, designed along modernistic lines and lists at \$99.75 f.o.b. factory.—*Radio Retailing*, December, 1934.



## Crosley Short-Wave Radios

Four new 6 and 7 tube all-wave radios, not replacing any of the present models, are now ready at the plant of the Crosley Radio Corp., Cincinnati, Ohio. They are Models 61EH, 614PG, 714GA and 714NA.

The six-tube sets cover the following bands 540-1,650, 5,800-15,330 and 1,650-5,000 kc. The seven-tube models cover 540-1,700, 5,800-15,350, and 1,700-5,000 kc.

The six-tube sets are housed in different cabinets from those of the present six-tube receivers, but the seven-tube models will be housed in the same cabinets as are the seven-tube two-band American and foreign radio receiving sets now in the line.

Model 61 EH table set is \$49.95 and the console is \$65. These are the six-tube sets.

On the seven tube jobs the prices are \$65 and \$85.—*Radio Retailing*, December, 1934.



Crosley Model 614PG

## Patterson Radios

The 1935 line of Patterson radios made by the Patterson Radio Co., 1320 S. Los Angeles St., Los Angeles, Calif., is now ready.

Headed by PR-12, successor to Model PR-10, the line covers 7, 8, 10 and 12 tube all-wave sets, chassis, table models, consoles and combinations. Crystal control is available. Other features include: R meter, modulation meter, monitor switch, new 6-section tuning condenser and double antenna input system.

The list prices are as follows: Chassis, \$47.50 to \$129.50; table models, \$54.50 to \$89.50; consoles, \$69.50 to \$169.50; radio-phonograph combinations, \$112.50 to \$159.50.

Model PR-12, the leader of the line, is a 12 tuber covering from 8-550 meters. It is a table model in a steel case with baked enamel finish. \$139.50. With crystal, \$149.50.—*Radio Retailing*, December, 1934.

## Egert Cathode Ray Tester

The new Model 500 cathode ray tester of Egert Engineering, Inc., 179 Varick St., New York City, is a combined visual resonance indicator, cathode ray oscilloscope and all-wave signal generator. It uses a 6F7, 75, 6A7, and an 84, as well as a rectifier for the cathode ray tube voltages. A 3-in. standard cathode ray tube is used for the visual indication. It covers the extremely wide range of 100 to 22,000 kc.

This tester has many features not found in devices of this type. The price is \$99.67 less tubes.—*Radio Retailing*, December, 1934.

## Gibson B-4 Refrigerator

Built to retail in the price range of the TVA "chest" type refrigerator (\$79.50) but of standard design with the door opening in the front, the Model B-4 electric refrigerator of the Gibson Electric Refrigerator Corp., Greenville, Mich. is now ready for distribution.

It is a full net 4 cu.ft. refrigerator. The overall dimensions are 23½ in. wide by 25½ in. deep by 43½ in. high. It has one ice-cube tray making 21 cubes.—*Radio Retailing*, December 1934.



Pilot Model C-114

## Pilot Model 103, 114, 6-114

The range of Model 103 of the Pilot Radio Corp., 37-06 Thirty-sixth St., Long Island City, N. Y., is from 16 to 52 meters on the short-wave band and from 178 to 550 on the broadcast band. This is a five-tube set giving eight-tube performance by the use of double and triple purpose tubes.

Models 114 and C-114 consist of eleven tubes having the equivalent of fourteen tube performance. The range of these receivers is 13 to 550 meters.—*Radio Retailing*, December, 1934.



## "Hi-Rate" Home Charger

A new and improved model of the "Hi-Rate Home Charger" is announced by the Automatic Electrical Devices Co., 324 E. 3rd St., Cincinnati, Ohio. This device recharges the automobile battery in the owner's garage. The rate automatically drops as the battery becomes charged.

The battery may be charged overnight at a cost in most localities of only a nickel. This new model employs a clamp-on receptacle which requires no tools and needs but a single connection to the ammeter terminal in the rear of the dash.—*Radio Retailing*, December, 1934.

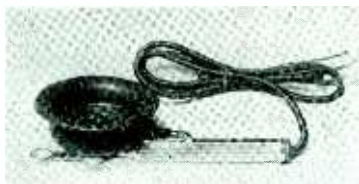

## Universal Aero Handi-Mike

Illustrated is the new aero handi-mike of the Universal Microphone Co., Inglewood, Calif., which can also be used on p.a. systems where the feedback condition is aggravating.

Universal is now making its Model E condenser microphone in two types. One will be for two 864 tubes, for all-battery operation, or filaments from battery and plate supply from a.c. power pack and the second model is built for two 230 tube filaments in series, can all be a.c. power pack operated without batteries of any kind.—*Radio Retailing*, December, 1934.

## "Moon-Glo" Electric Clock

A new idea in modern electric clocks has been brought out by Viking Products Corp., 330 W. 42nd St., New York City. The upper part, dial and face, is crystal glass and the metal base houses a small bulb which illuminates the etched and silvered field of the dial. Clock numerals and dial are readily legible when not illuminated.

This attractive and decorative clock is ideal for living room or bedroom. Overall size is 7½ x 7½ in. Base is die cast metal, nickel finish. This clock will retail for about \$12.50.—*Radio Retailing*, December, 1934.

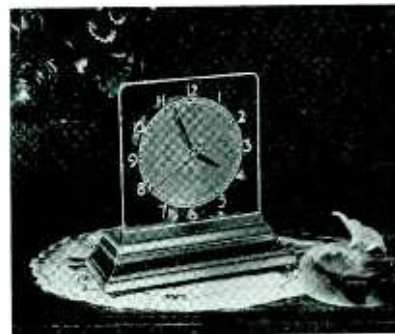

## Lynch "Airods" for 5 Meter Sets

The wide spread and rapidly growing interest in 5 meter operation, especially for portable and mobile installation, with similar activity just starting on 2.5 meters, brings a demand for a good antenna which may be easily attached to car, airplane or house installation. The new "Airods" of the Lynch Mfg. Co., 227 Fulton St., New York City, are the direct result of this need and of many tests in all three fields. They are made in four distinct types to suit almost any requirement in the most convenient manner.

The prices are: auto type (¼ wave, 5 meter, 2 sections), \$3.50; aircraft and ground station types—¼ wave, 2.5 and 5 meters, 3 sections, \$4; ½ wave, 5 meter, 4 sections, \$7; ¾ wave, 2.5 and 5 meter, 6 sections, \$7.50.—*Radio Retailing*, December, 1934.

## "Dynatest" Speaker

The "Dynatest" speaker of the Radolek Co., 601 W. Randolph St., Chicago, Ill., is intended for use as a substitute speaker for any radio chassis brought to the shop without its regular speaker; as a test speaker to determine if the regular speaker is at fault and as a temporary portable p.a. speaker. A special 11,000 ohm field coil has 8 taps connected to a selector switch permitting the choice of all standard field coil resistance values. Two special taps are provided for use with sets having tapped speaker fields.

Two special voice coil impedance matching transformers with 8 taps each are connected to binding posts and selector switches to permit matching the Dynatest speaker voice coil to an output tube circuit or to any output transformer secondary.

The speaker and 3 switches with universal pin-plug-spade binding posts is mounted on a 12x12 in. panel in a portable fabricoid carrying case. The retail price is \$22.50.—*Radio Retailing*, December, 1934.

## Guthman Coils

Edwin I. Guthman & Co., Inc., 1621 S. Michigan Ave., Chicago, is showing a complete line of coils systematically listed so that the particular needs of the service man can be readily filled. Included are shielded antenna and r.f. coils, unshielded antenna and r.f. coils, antenna and oscillator coils for superheterodyne use, combination short wave and broadcast antenna and r.f. amplifier coils, short wave plug-in coils, choke coils.

Guthman also makes a complete line of i.f. transformers.—*Radio Retailing*, December, 1934.



## Raytheon "Rectifilters"

The Raytheon Mfg. Co., 190 Willow St., Waltham, Mass., has acquired the "Recti-Filter" business of the Square D Co., Detroit, Mich. These units will now be manufactured and shipped from Waltham and will continue to be known as "RectiFilterRs."

Rectifilters are devices for changing a.c. to d.c., the conversion being effected with no moving parts. They consist of transformers, rectifying elements, choke coils and condensers. In some cases meters, relays, switches and other control equipment is included.

They are designed for operation from any a.c. power circuit and by appropriate design of the transformers and rectifying elements can be made to deliver d.c. at almost any combination of voltage and current. The entire assembly is mounted in a suitable code box and marketed as a unit.—*Radio Retailing*, December, 1934.

## Jefferson Amplifiers

Jefferson Electric Co., Bellwood, Ill., offers several amplifiers.

Class B "59" has a resistance coupled stage consisting of a 57 tube employed to provide high gain. An improved bias arrangement has been incorporated. Power output: 15 to 20 watts, 34 to 35.2 db.

Model 2B6 amplifier foundation kit, consisting of transformers, chassis and chokes, etc., makes it possible to build a complete amplifier at a popular price.

Model 2A3 is designed to and actually develops the full listed output of the 2A3 tube—15 watts. Through the use of 56 drivers and the Jefferson special driver transformer, the power tube grids can be driven positive, resulting in the 15 watt output being increased to 25 watts with only moderate distortion.

With Jefferson's amplifier chassis, the service man is able to construct a power amplifier which in appearance and performance is comparable with standard complete amplifiers. It is designed primarily for the amplifier circuits described above but can be used in constructing power amplifiers of various types. \$2.—*Radio Retailing*, December, 1934.

## Solar Midget Low-Voltage Electrolytics

The new midget series of dry electrolytic condensers just announced by the Solar Mfg. Corp., 599 Broadway, New York City, is a boon to service work in modern compact radio sets. The Red Star 200-volt electrolytics occupy less space than similar capacity low-voltage sections. This series is furnished with leads. They range in price from 65 cents to \$1.25.

A midget kit is also offered containing fifteen of these condensers in most needed sizes. List price \$12.95.—*Radio Retailing*, December, 1934.

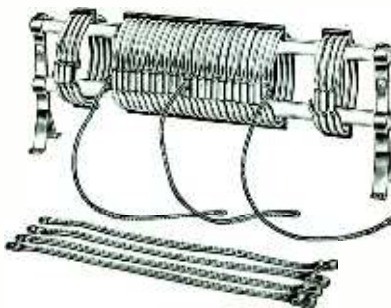

## Thordarson Universal Transmitting Inductance

Separate coils are no longer necessary for each wave band on which transmitters are operated if the new universal transmitting inductance of the Thordarson Electric Mfg. Co., 500 W. Huron St., Chicago, is used. This inductance provides a single unit that covers all amateur and commercial transmitting bands from 20 to 160 meters. It is a helically-wound coil of copper tubing, 4½ in. in diameter, divided into a number of four-turn coil units. Each coil is joined to the adjacent coil by a removable clip and each turn is joined to the succeeding turn by a similar clip. Thus the units are variable in one-turn steps.—*Radio Retailing*, December, 1934.

## Turner P.A. System and Amplifiers

Model S-16 portable P.A. system of the Turner Co., Cedar Rapids, Iowa, is completely housed in a leatherette covered case. The equipment includes a mike, 30 ft. of microphone cable, amplifier, 35 ft. of speaker cable and a speaker. Either one or two speakers may be used. Technical specifications: 3 high gain stages; uses 2-57, 2-2A5, 5Z6; total gain, 111 db.; power output, 8 watts. Overall dimensions are: 20x13x8 in.

Three amplifiers are also made by this company. Model MC16 is a class A amplifier which does not require a pre-amplifier when used with the Type G crystal microphone. Input is provided for a high impedance phonograph pick-up. Furnishes the field supply for one dynamic speaker with 6,000-10,000 ohm field. A 7½ ohm output line is also supplied. Power output: 8 watts. Uses 6 tubes: 57, 2-56, 2-2A5, 5Z3.

Model MC50 is a high gain class B amplifier with input for crystal microphone. The power output is 22 watts. Tubes used: 2-57, 3-46, 83. Four high gain stages.

A line amplifier for P.A. men who require a flat frequency response of 30-12,000 cycles is also a part of the line. Used in connection with the Type G crystal mike it is splendid for remote pick-ups. Uses 2-57 and an 80.—*Radio Retailing*, December, 1934.

## Clough-Brengle Vacuum Tube Voltmeter

Servicemen who have need for a vacuum tube voltmeter in portable, always-ready-to-use form have usually been limited to home made or laboratory units. With the announcement from the Clough-Brengle Co., 1134 W. Austin Ave., Chicago, of its new vacuum tube voltmeter, servicemen may now purchase an accurately calibrated tester. This Model UC will read potentials as low as .2 volt without drawing any current from the circuit under measurement. It has practically infinite resistance, well over 10 megohms on the lowest voltage range.

Likewise it is designed for measurement of voltage at both radio and audio frequencies. These properties give it wide application for uses such as: measurement of audio and r.f. gain, hum level, noise level, locating shorted r.f. and a.f. coils and impedance of transformers and speaker voice coils.—*Radio Retailing*, December, 1934.



## 83V Sylvania Tube

The type 83V just announced by the Hygrade Sylvania Corp., 500 Fifth Ave., New York City, is a heater cathode type high vacuum rectifier designed for full-wave circuit applications. The heater requires 1.75 amp. at 5 volts. This differs from the rating for type 83, which takes 3 amp. at 5 volts. The d.c. output current (175 ma.) is intermediate between the ratings for types 80 and 5Z3.

The 83V is not directly interchangeable in some cases with the mercury vapor type 83, since the recommended maximum plate voltage is only 350 volts r.m.s. per plate and the d.c. output current is limited to 175 ma. The price is \$1.10.—*Radio Retailing*, December, 1934.

## New "Cordohm" Values

Two new resistance values, 220 and 330 ohms, have recently been added to the line of Cordohm line cord resistors made by the Ohmite Mfg. Co., 636 N. Albany Ave., Chicago, Ill. It is now possible to secure units for any a.c.-d.c. radio whose total filament voltage is between 18 and 75 volts.—*Radio Retailing*, December, 1934.

## These Three Rooms (Continued from page 13)

the set, why it will do certain things that the table model he has just purchased will not do, and, to prove our contentions, we offer to bring in the set he has just purchased and demonstrate the difference.

"It is very important that one have facilities for hooking up a set quickly. We can hook up a table model in 5 seconds because we have two-foot cables with spring clamps on each end. We attach one end to the aerial post and the other to the aerial that runs around the sides of the room at a height of 30 inches. We set the table model on top of the cabinet model and compare their tone qualities.

"Three out of every 10 who have just purchased a set will ask that the contract be destroyed and a new one made out for a cabinet set. This is the way we build up our sales. No high-pressure methods are

necessary. A complete demonstration and a full and truthful explanation suffice.

"Our sales organization consists of the two of us on the inside all the time, and an outside man for each of us. The outside men receive small salaries and a split on commissions on sales in which they had a hand.

"If a prospect leaves the store this afternoon, for example, without making a purchase, a card is made out and handed to one of the outside men the next morning. Before noon he will have called upon the prospect.

"However, we waste no time on any prospect who declines to give us his name and address and leaves without making a purchase but assures us he'll see us later. The time spent in running down such a prospect may be used to better advantage in making calls on old customers and in serving those who come into the store."





Here's one of the reasons behind the big pick-up in record sales—

# RCA VICTOR RECORD PLAYER

**\$16<sup>50</sup>**  
LIST PRICE

Transforms any modern AC radio into a fine electric phonograph—and doubles its value!



**T**HERE was a time when some customers denied themselves the privilege of playing records because they couldn't afford to buy a modern combination.

But that's all over. For this new RCA Victor Record Player furnishes the highest degree of satisfactory performance at a price that places it within the reach of everyone—\$16.50! When it is attached to a radio, it produces the roundest, sweetest and fullest tone ever heard from that machine! The popularity of this new Record Player has already been established! Its effect is felt everywhere, as record sales show tremendous increases over last year.

Here's why the smart merchants are getting behind this new Record Player. In itself, it shows you a nice profit—in the long run, it multiplies that profit many times in the fertile field for record sales it opens up! Keep it playing new Victor Records in your department! Let all hear the unrivalled crispness and definition—never before achieved in *any* kind of reproduction! Fill out the coupon now to learn all the details of this business-building opportunity—also about the new BlueBirds, fastest selling low-priced records!

Plays 10" or 12" records. The Record Player is neat, compact; size 5" high, 8" wide and 10 7-8" long. Beautiful walnut-finished chest.

**Get These New Victor Releases**

- 24769—YOU'RE THE TOP—Fox Trot  
I GET A KICK OUT OF YOU—Fox Trot  
(Both from Musical Comedy, "Anything Goes")  
Paul Whiteman and his Orchestra
- 24766—YOU'RE THE TOP  
THANK YOU SO MUCH,  
MRS. LOWSBOROUGH—GOODBY  
Sung by Cole Porter
- 24801—DREAM MAN—Fox Trot  
I'M GROWING FONDER OF YOU  
"Fats" Waller and his Rhythm

IT PAYS TO SELL  
**VICTOR RECORDS**



THEY'RE "HIGHER FIDELITY"

RCA VICTOR COMPANY, Inc.  
Camden, N. J.

I want to get in on this new sales opportunity—let me know all about the new Record Player and send me a complete list of the latest Victor Records.

Name.....

Address.....

.....

R.I.

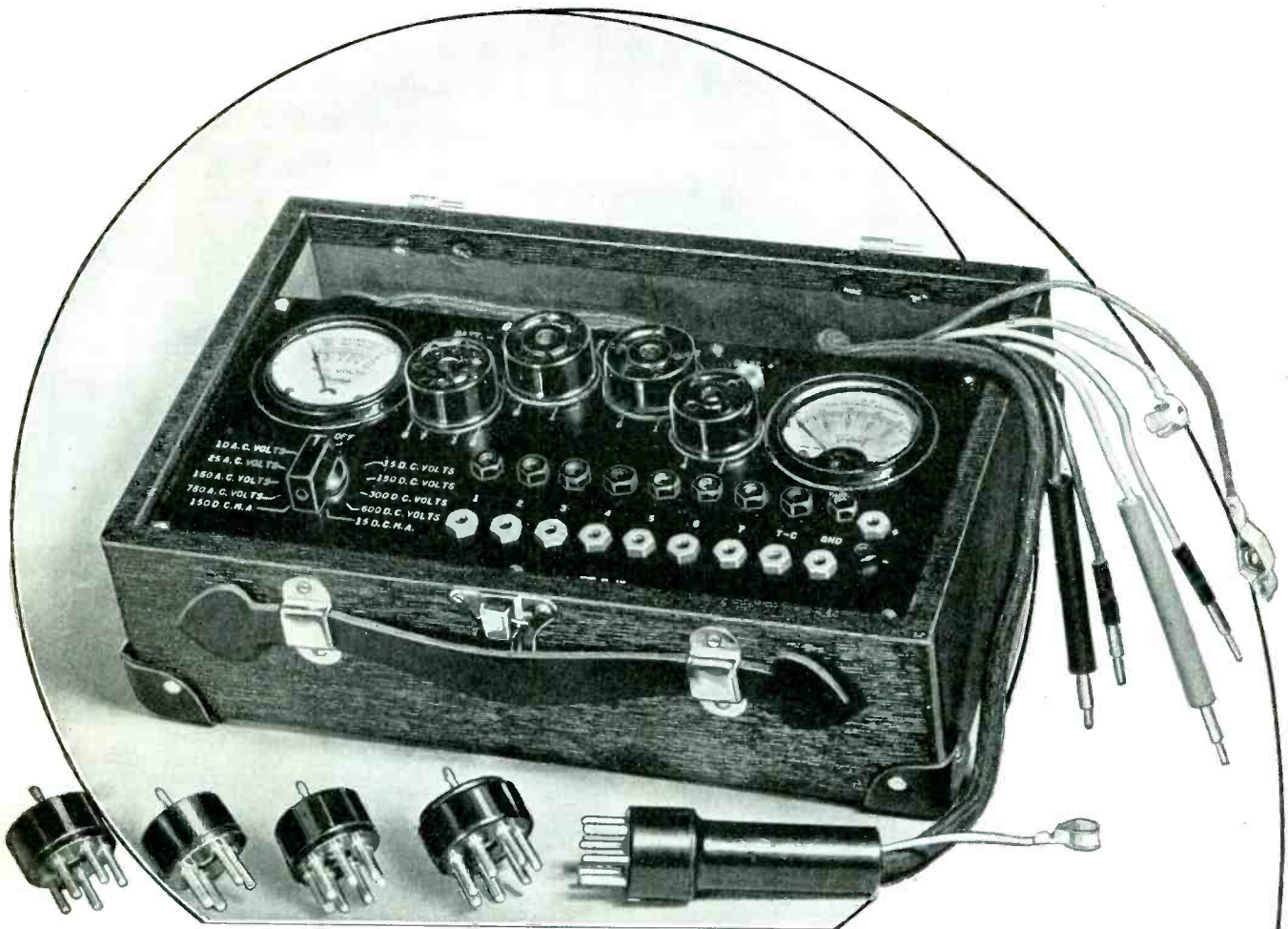

## HARD-TO-FIND TROUBLE SPOTS

# *Now Quickly Located!*

NO longer need you waste hours puzzling over a set as you try to locate some trouble spot. No longer need you depend on guesswork and hit-or-miss methods to service a radio.

Up and coming service men know inefficient equipment means lost time, inaccurate work and unsatisfactory results. More and more, they are turning to the Readrite No. 730

Tester because it takes the guesswork out of servicing and enables them to quickly and accurately locate trouble spots, such as:

Corroded connections that cause frequency drift . . . intermittent operation caused by defective chokes, by-pass or coupling condenser . . . cold soldered joints . . . distortion due to leakage between the anodes of the electrolytic condensers . . . and many others.

The No. 730 Point-To-Point Tester is designed especially for speedy and efficient servicing. It is extremely flexible. Voltage can easily be checked in any tube circuit. Also measures resistance, capacity and continuity. Tester socket terminals are arranged according to RMA standards. It is unnecessary to remove chassis from cabinet when localizing defects.

This tester includes two meters—one for reading AC, the other for DC. These meters are rugged, compact and accurate. Separate meter ranges are made possible by connecting to a single pair of jacks and using the selector switch. DC. ranges are 15, 150, 300 and 600 volts. (1,000 ohms per volt). Milliampères are 15 and 150. The AC. voltmeter ranges are 10, 25, 150 and 750.

**YOUR JOBBER CAN SUPPLY YOU**  
At the dealer's net price of \$18.60

## READRITE METER WORKS

140 College Avenue, Bluffton, Ohio

### MAIL COUPON FOR CATALOG

Readrite Meter Works,  
140 College Avenue, Bluffton, Ohio

Send me catalog on Readrite No. 730 Tester and folder proving Readrite leadership.

Name .....

Address .....

City ..... State .....



# SERVICE SECTION

Conducted by  
W. MacDonald

Including  
Installation Data

## CIRCUITS of the MONTH

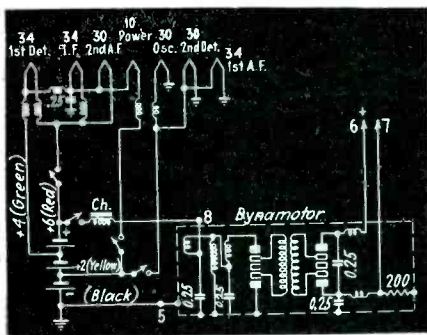

### 6-Volt Receiver Taps Battery Cells

A number of interesting circuit ideas are incorporated in the Wells-Gardner 7-tube, 6-volt series. These sets, for example, operate from a storage battery, use a dynamotor for B-supply. One cell of the battery is tapped to apply 2 volts to the first detector, i.f. tube and second a.f. stage filaments. A second cell heats the power tube filament. And the third supplies filament potential to the oscillator, second detector and first a.f. stage. Note, also, the inclusion of an elaborate system of r.f. chokes in critical filament leads. These avoid feedback of r.f. or i.f. which is sometimes troublesome. A .25 mike condenser from i.f. filament to ground further completes the filtering.

The dynamotor is driven from the entire storage battery output through an iron-core choke. This choke has extremely low resistance, so low that the manufacturer does not rate its d.c. ohms. Dynamotor output is filtered by the inclusion of two r.f. chokes

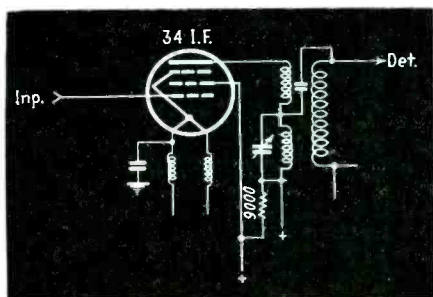

### Speaker Energized By 25Z5 and Auto-Transformer

Magnavox makes use of the auto-transformer principle in an interesting fashion to permit operation of its Model 522 speaker on 120, 150 or 240 volts a.c.

The operation of the auto-transformer to permit adaptation of the high-voltage input section (A to B) is obvious. There was some question regarding the application of a suitable voltage to C under different supply conditions, however, and the Editor secured the following explanation from chief engineer Fred Kranz:

"The conditions necessary for keeping 120 volts across the terminals A and B are the same as those necessary for keeping the output voltage of the winding C constant. Thus there are twice as many turns between the point B and the 240 volt tap as there are between the points B and A. This means that the 240 volts is stepped down into the winding C by twice the ratio that the 120 volts would be stepped down into the winding C. Thus it appears that the winding C would have the same output voltage requirements of the tap used."

in the output leads and a .25 microfarad shunt condenser. Ground connection from the high-voltage negative is made through 200 ohms. Note the inclusion of a number of .25 mike units in the dynamotor assembly proper to further guard against "hash." The rather elaborate switching system is also of interest, four being ganged.

Another unusual kink is found in the i.f. output circuit. Combination inductive and capacitive coupling is used. Note, also, that only part of the primary of the i.f. transformer is tuned.

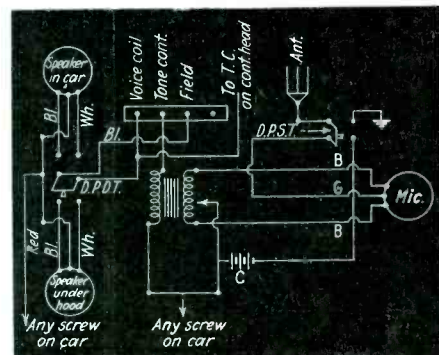

### Car Radio Equipped With "Mike"

The M and M Company, "Motorola" distributor, has an interesting method of equipping a "Twin-8" for ballyhoo or public address work. An extra speaker is installed under the engine hood, double-button carbon mike, d.p.s.t. switches installed as shown in the diagram. One switch cuts the set output from one speaker to the other. The other switch grounds the antenna and cuts in the mike, silencing radio reception and simultaneously permitting the application of mike voltage through a microphone transformer.

### Open Tube Element Detector

The diagrammed circuit designed to permit the serviceman to detect open circuited tube elements is incorporated in Jackson Electrical Instrument's Model K portable checker.

Briefly, it operates as follows: The filament or heater of any tube may be energized from a properly tapped low voltage secondary. An a.c. potential is applied to all other elements through resistors R, which are in the order of one half megohm and allow a small amount of current to flow from each element back to the cathode of the tube. The voltage developed across these resistors is sufficient to cause a sensitive neon lamp to glow.

To use the circuit one test prod (k) is touched to the cathode base pin of the

# AND NOW! \$12 CONDENSER ANALYZER ADDED TO SUPREME 85 NEONIZED TUBE TESTER AT NO EXTRA CHARGE

Shorts and leakages in capacitors have been responsible for many a kick-back on repair jobs which apparently checked 100% when they left your lab. Baffling faults in Automatic Volume Control circuits that finally caused a trip of the set back to the factory, or the replacement of every capacitor in the circuit, have had the root of their trouble in capacitor leakages that not even a high-range ohmmeter could detect. Knowing this, alert radiomen are now awake to the fact that a 100% job of modern servicing must include a complete condenser (or capacitor) analysis.

And Supreme—the organization of practical radio servicemen and engineers—now gives it to you. Includes it as a still further distinction to the most distinguished tube tester in radio service work. Think of it, a \$12.00 condenser analyzing equipment is now incorporated as standard design in SUPREME 85 "NEONIZED" TUBE TESTER. Without a penny of extra cost!

Now that famous, unerring Neon light provides analysis of capacitors as well as of tubes. Positive detection of leakages, shorts, opens. Every desired test of any capacitor, regardless of size.

And every serviceman can well afford to modernize with the SUPREME 85. Not only because it is low in first cost, but particularly because it soon returns first cost and plenty more besides, and because it puts your service on a 1935 plane, giving you a 3 in 1 Tester, namely (1) TUBE TESTER, (2) TUBE LEAKAGE TESTER, (3) CONDENSER ANALYZER . . . at the price of one.

As part of its service to Supreme owners, and realizing that its own reputation is built on the reputation of the users of its instruments for a progressive service, SUPREME makes this high class condenser analyzer equipment available to present owners of Model 85 at nominal cost. Write for information.



DEALERS NET CASH WHOLESALE PRICE \$ **39.<sup>95</sup>**

"The Neon Light Lit Up, Oh So Beautiful . . . I Could Easily See The Hum Trouble Then."

Actual experience of radio men is the soundest evidence of the new paths in service accuracy blazed by the SUPREME "NEONIZED" 85 TUBE TESTER. Witness the letter herewith from Mr. E. R. Arnold. Typical of untold others. Buy the tube tester that gives you most in satisfied customers . . . at no extra cost.

SUPREME INSTRUMENTS CORP.,  
514 Supreme Bldg.,  
Greenwood, Miss.  
Please send complete detailed catalog 1935 Supreme instruments.

Name.....  
Address.....  
City..... State.....  
Jobber Preference.....

Ask your jobber for a demonstration of this most outstanding tube tester in radio service work and other Supreme instruments. Send accompanying coupon for complete 1935 Catalog.

SUPREME Model No. 35 Tube Tester \$29.95

SUPREME Model No. 333—Standard Radio Analyzer \$39.95

SUPREME Model No. 333—DeLuxe Radio Analyzer \$39.95

Saltville, Va., Nov. 16, 1934  
SUPREME INSTRUMENTS CORPORATION  
Greenwood, Miss.  
Gentlemen:  
I would like to say just what I told an important customer the other day. This customer being quite a radio man himself had fully realized the joy of radio and had purchased a Stromberg-Carlson Telektor outfit with a Capehart Automatic Phono. The receiver had been performing beautifully until recently when there was a hum setup in the set. I was called on to service this receiver and to my dissatisfaction I did not find this trouble. However, I advised my customer that I had some new testing equipment coming and would make another checkup. He agreed to wait and here is where SUPREME came in. The first thing I did was to recheck the tubes. The fourth tube checked, made my heart leap. The Neon light lit up oh so beautiful. I then noticed the button to see what part of the tube was shorted and found the filament shorted to the cathode. I could easily see the hum trouble then. And a new 27 installed corrected the trouble. My remark to the customer was, that I believe I would send Supreme Company another \$25.00 as the instrument was worth a lot more than its cost. Supreme has helped the serviceman, and the serviceman should be glad to help Supreme. You may count on our shop being a fully Supreme booster. We contemplate ordering another DeLuxe 333 within the next few days.

Very truly yours,  
E. R. Arnold  
RADIO SERVICE SHOP

MANY THANKS MR. ARNOLD NEVER MIND THE "EXTRA \$25"



# SERVICE SECTION

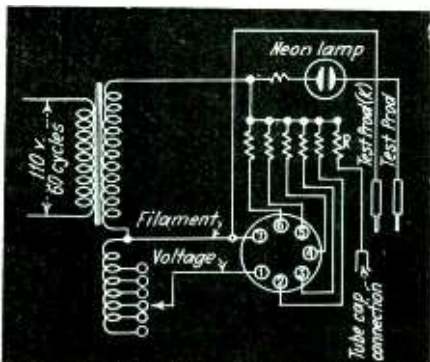

suspected tube and the other touched successively to the other pins. If the neon lamp fails to glow on any element that particular element is open from its base pin. This circuit is extremely useful in connection with some of the more complicated tube types.

## Variable Selectivity Control

Here's a variable selectivity control idea used in the K.B. 383 (British) to facilitate high-fidelity reception where conditions permit the use of broad band width. Like a system suggested by one of our own leading development laboratories (RR35June) coupling between primary and secondary of the i.f. transformers may be mechanically adjusted from the front panel.

With the coils spaced the greatest distance the i.f. transformers operate just below critical coupling, giving extremely sharp selectivity. When the coils are brought close together by the cam action the transformers are over-coupled and broad band-pass characteristics result. Band width can be altered from about 3,000 cycles, normal for most receivers used in Europe, to about 7,000 cycles.

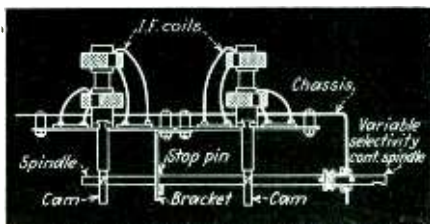

## Reflexed 2B7 As 2nd Det., A.V.C., I.F. and A.F. Amp.

The 2B7 has been reflexed to do almost everything but put out the cat in other receivers but not in quite the same manner as in the Emerson D-S5.

I.F. is applied to the control grid (a .00025 condenser serves as grid-return to cathode) and appears, amplified, across the tuned plate coil. A tuned "trap" (shunted by two series .00025 condensers) just below the plate coil keeps amplified i.f. from passing to the

p.a. stage. It passes by transformer action, however, to the two paralleled diode plates.

Rectified signal current is developed across the diode load (500,000 and 100,000 ohm resistors) and a.v.c. voltage for preceding r.f. and pentagrid-converter tube grids taken from the midpoint between these load resistors. A .00025 condenser connected at the midpoint bypasses any i.f. which may get into this circuit to ground.

A.f. is also taken from the midpoint between diode load resistors and passes to audio load resistors (fixed 500,000 and variable 500,000) through a .05 condenser. The fixed 500,000 ohm resistor serves as a filter to keep i.f. out of the audio load. From the variable arm of the lower a.f. load resistor a.f. passes back to the control grid (reflex) and amplified a.f. appears in the plate circuit, passing through a .02 blocking condenser to a 250,000 ohm tone control from which the final p.a. stage is fed.

The D-S5 has another interesting cir-

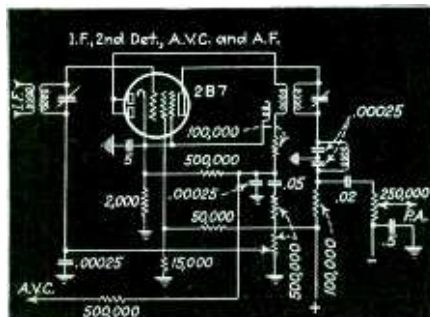

cuit kink. A coil equipped with a shunt condenser which tunes it to 456 kc. (the i.f.) is included in the antenna lead and serves as an absorption "trap" to keep signals of this frequency from barging through the 2A7 detector-oscillator. The trap apparently serves in lieu of an r.f. stage.

## Shorted Broadcast Coils

The business of grounding both ends of unused coils when working with higher-frequency circuits, which avoids dead-spot trouble to a marked degree, is getting so common that this is positively the last time we intend to mention it.

The Montgomery-Ward OC series 10 tube double-band jobs (Wells-Gardner) use the system in pre-selector, oscillator and r.f. stages. The pre-selector circuit diagrammed is typical. Note that the broadcast and shortwave primaries, coupled to their respective secondaries, are in series. When the set is used on shortwaves (as shown) the shortwave secondary is substituted for the broadcast by Sw 1, and Sw 2 automatically shorts out the latter. When used in the broadcast position Sw 1 cuts the shortwave secondary out and substitutes

the broadcast coil but does not short the shortwave secondary.

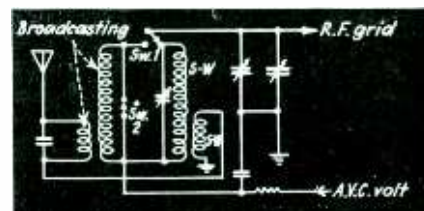

## "AUDIO FREQUENCY"

THE LATEST CIRCUIT WRINKLE encountered in the laboratory is "a.f.c." . . . automatic frequency control to you! It seems that the frequency of an oscillator circuit is controlled not only by the capacity and inductance but also to a limited extent by the amount of resistance in the circuit. Thus, if the cathode-plate resistance path of a separate vacuum tube is placed in series with the oscillator "tank" circuit inductance the emitted frequency can be varied slightly by changing the grid-cathode voltage of the control tube. Action can be made automatic by taking this grid-cathode voltage from a part of the circuit which is controlled by the frequency of the tuned circuit. The idea is particularly applicable to shortwave receivers. A.v.c. voltage can, for example, be applied to the grid of the a.f.c. tube hooked up to work in conjunction with the oscillator. As the oscillator drifts the a.v.c. voltage changes, the control tube resistance changes and the oscillator frequency is brought back to its original value by variation of resistance in series with its tuned circuit.

RESONANT PIPES OR TUBES designed to bring up low-frequency audio response have been tried before. It appears, however, that the idea may be revamped for use in connection with new high-fidelity receiver design. A certain nationally-known manufacturer is experimenting with a resonant pipe not unlike that of an organ (but much smaller, of course) and reports interesting results.

IT SEEMS TO THIS PERAMBULATING editor that the trend toward all-steel automobile bodies will some day "rub out" soft tops. And when this day comes there will be much scurrying hither and yon for auto-radio antenna ideas. Set manufacturers will no doubt help, if and when this rather wild-eyed prophesy comes true, by increasing the sensitivity of car receivers. Which will again intensify the ignition noise suppression problem . . . but why bring that up! Life is enough of a puzzle as is.



# IT'S ONLY A PENNY

WHY BE PENNY WISE AND CONDENSER FOOLISH

Doing business with the leader in any line of industry brings a comfortable feeling of security. You expect a product that is superior from any point of view... you get it!

Why trifle with "bargain" condensers? Why give your customers condensers that do not assure you of trouble-free service and the elimination of "come-backs?" Why take chances when you can be sure with C-D's.

In the act of spending a few pennies more, you inherit the security of **QUALITY**. Remember: the United States Government, scientific expeditions, the leading 150 set manufacturers **DEMAND CORNELL-DUBILIER** Condensers. In justice to yourself and to your customers... use C-D's every time! There's a capacitor for every job—in the world's most complete condenser line — Cornell-Dubilier.

**FOR INSTANCE:** the type RHM units—equipped with wire leads—encased in silver carton—double sealed against deteriorating effects of climatic changes. Convenient for those tough repair jobs on the modern AC-DC receivers. Complete replacement line available

• WRITE TODAY FOR YOUR COPY OF OUR LATEST CATALOG AND OTHER VALUABLE DATA •

Cat. No.	Cap. Mfd.	Size (Inches) H W D	List Price	Your Cost
TYPE RHM—NEW SMALL SIZE, WIRE LEAD, HANDY-MIKE UNITS				
450 Volt—Single Section Cardboard Container Condensers—5% Peak				
RHM-9010	1	2 1/2 x 1 1/2 x 1 1/2	\$ .55	\$ .33
RHM-9020	2	2 1/2 x 1 1/2 x 3/8	.65	.39
RHM-9030	4	2 1/2 x 1 1/2 x 1/2	.75	.45
RHM-9080	R	2 1/2 x 1 1/2 x 1 1/2	.95	.57

**CORNELL-DUBILIER CORPORATION**

4399 BRONX BOULEVARD • NEW YORK

## READY NOW!

Make 1935 more profitable with

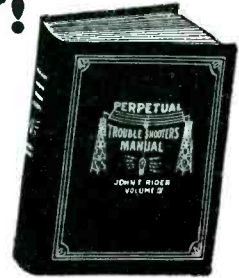

### RIDER'S MANUAL VOLUME V

1200 pages . . . index not counted  
Products of 112 manufacturers  
Up to the minute—No duplication  
Separate 64 page index

- Vol. I . . . . . 1000 pages . . . . . \$7.50
- Vol. II . . . . . 800 pages . . . . . 6.50
- Vol. III . . . . . 1180 pages . . . . . 7.50
- Vol. IV . . . . . 1060 pages . . . . . 7.50
- Vol. V . . . . . 1200 pages . . . . . 7.50
- Servicing Superheterodynes . . . . . 1.00

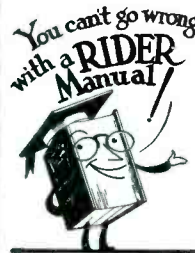

No advance in price for this very best of all manuals in the field.

**MONEY-BACK GUARANTEE**

**John F. Rider, Publisher**

1440 Broadway New York City

Are you receiving **SUCCESSFUL SERVICING?** This eight-page house organ is **FREE**. It contains service data of value in connection with Rider's Manuals.

## REPLACE AUTO RADIO VIBRATORS WITH PIONEER GEN-E MOTORS



DON'T LET SERVICE COSTS ROB YOU OF PROFITS!

Pioneer Gen-E-Motors make ideal plate power supplies for all auto radios. Compact, dependable, easy to install. No later readjustments to cut your profits. Types for 6, 12, and 32 volt battery systems, with outputs to 300 volts. Also complete line of D.C. to A.C. converters.

**PIONEER GEN-E-MOTOR CORP.**

466 W. Superior St., Chicago, Ill. WRITE FOR FREE DATA TODAY!



**UNIVERSAL ALL-WAVE ANTENNA SYSTEMS**

ARE EASY TO INSTALL!

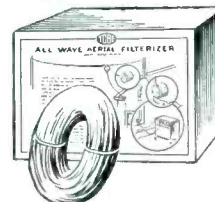

TOBE universal antenna kits can be erected as doublet aeralis or as ordinary flat tops (Marconi)—depending upon the convenience of the location. Aerial and receiver transformers permit this flexibility and insure **MAXIMUM SIGNAL STRENGTH** and **MINIMUM NOISE PICK UP**.

Model 35—\$4.95 List.

**TOBE DEUTSCHMANN CORPORATION**  
CANTON, MASSACHUSETTS



## HOW TO READ SELECTIVITY AND FIDELITY CURVES ON A CATHODE-RAY OSCILLOGRAPH

By KENDALL CLOUGH

Chief Engineer  
The Clough-Brengle Company

THE day is virtually at hand when the cathode ray tube will be to the radio servicing profession what the X-ray machine is to the medical arts. In fact, its function is closely analogous. Doctors had long been able to check the actions caused by organic difficulties, much as servicemen can now measure with meters results of circuit adjustments. The cathode ray tube brings the ability to actually see the circuit in function, just as does the fluoroscope reveal the heart's position and beat action.

The application of cathode ray equipment for alignment of circuits is of great interest. It is now possible to throw on the screen of the cathode ray tube the exact frequency response curve of a tuned circuit, usually obtained only by plotting data secured from measurements that require many hours of work. Ordinarily in service and production

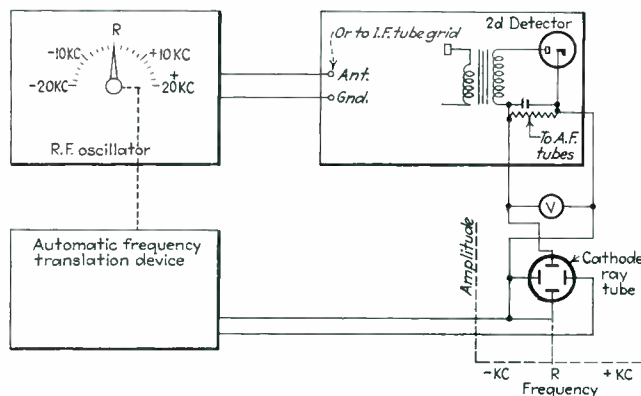

FIG. 1

alignment, attention is paid only to the frequency at which the peak of the response curve comes, as indicated by the deflection of an output meter. This neglects the actual shape of the curve, at what frequency cut-off occurs, and all irregularities of shape. Servicemen have, however, learned to watch quite closely for such simple distortions of curve shape as "double peaks" that can be detected with an output meter.

It is easy to see that the location of the curve peak tells but little of the true story. The actual shape of the curve plays an important part in determining selectivity and tone quality of the receiver. Servicing new wide-range high fidelity receivers requires that the shape of the response or selectivity curve of the r.f. circuits be accurately known.

### Tester Principle

Several means of making the curve appear on the screen of a cathode ray tube have been developed, but are all alike in general principles. They may all be illustrated by the block diagram in Fig. 1. At the upper left of this diagram is a radio frequency oscillator and at the upper right

the radio receiver to be studied. If an overall frequency response curve is desired, the oscillator is set at some point in the broadcast band and the set is tuned to it. If the selectivity curve of the i.f. stages alone is desired, the oscillator is set to the i.f. frequency of the set and connected directly to the grid of the i.f. tube. In either case, the result is very much the same.

With the connections made in this diagram, and the oscillator generating an unmodulated signal, now assume that a small calibrated vernier condenser is placed in series with the main frequency selector condenser of the oscillator, such that it may be detuned off resonance a few kilocycles on either side.

Since the test signal is unmodulated, no response would be obtained with an output meter, the best indication of the strength of the test signal would be obtained by measuring the voltage across a resistor in the plate circuit. (For sake of illustration a diode detector has been used.) It will be found that at resonance there is a material increase in the voltage across the resistor in the plate of the diode. This voltage falls off as the frequency vernier is manipu-

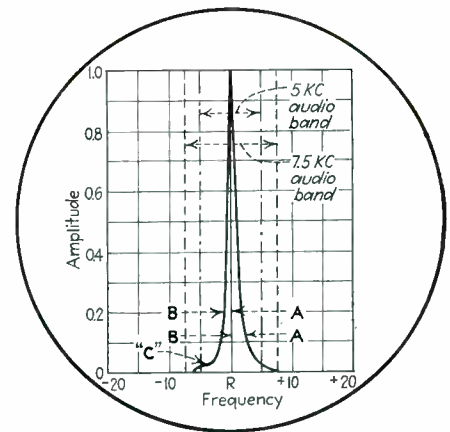

FIG. 2

lated off resonance to either side due to the selectivity of the receiver. If the frequency of the test signal from the oscillator were varied 1 kc. at a time to either side of resonance, and the readings of the meter V plotted, the result would be the selectivity curve of the receiver.

Thus, if the vertical deflecting plates of the cathode ray Oscilloscope are connected across the voltmeter, the spot on the screen will move up and down in proportion to the voltage, marking on the screen a vertical scale of amplitude.

Now if the dial of the frequency vernier were connected through a device which could translate its movement into a voltage proportional to such movement (negative below resonance and positive above resonance), such voltage could be applied to the horizontal deflecting plates. Thus the cathode ray tube screen could be provided with a horizontal scale, marked "Frequency." Zero voltage will, of course, correspond to the point of resonance on this scale. (The exact frequency of the intermediate system.)

With such an arrangement, moving the frequency vernier back and forth, will plot the selectivity curve of the set on the screen at the end of the cathode ray tube. If the frequency knob is reciprocated at a speed greater than 12 or 13 times per second, at a uniform speed (Ed. Note: Automatically accomplished within the cathode ray testing device) the human eye, due to persistence of vision, will see a steady curve of selectivity.

What is important to the serviceman, this

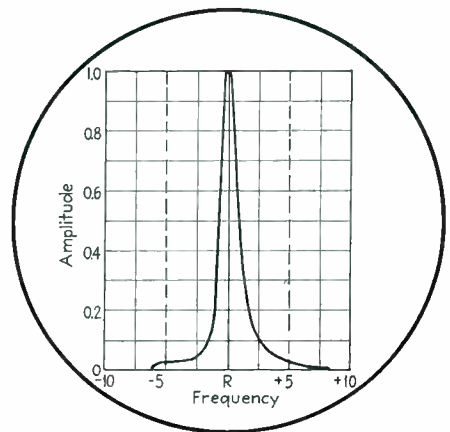

FIG. 3



- NEW—LOW PRICES. 10 Watt Unit now only 21c net. (\*)**
- NEW—Higher wattage ratings—smaller sizes.**
- NEW—Cement coating. Durable—dissipates heat quickly.**
- NEW—A COMPLETE line—Low Wattage, High Wattage, Fixed and Adjustables, Higher resistance limits.**
- NEW—IRC Power Wire Wound Resistor Catalog containing helpful resistance data and computation charts. Write for a copy today—Ask for R-100.**

(\*) Prices slightly higher in Canada.

**INTERNATIONAL RESISTANCE CO.**  
 2100 ARCH ST., PHILADELPHIA, PA.  
 (In Canada, 187 Duchess St., Toronto, Ont.)

# IRC RESISTORS

REG. U.S. PAT. OFF.



**National Union plays Santa Claus to Service experts all year round!**

NATIONAL UNION gives tube testers, set analyzers, oscillators and service manuals with tube purchases. National Union gives these valuable instruments and servicing books so that service dealers can build a bigger better more efficient business for themselves. The instruments are all brand new models made by such famous makers as Supreme, Hickok, Triplett and Egert. The manuals are compiled by John F. Rider.

The alert Service-Dealer who equips himself the easy National Union way knows his equipment is backed both by the maker and National Union.

National Union gives service charts and data not available from any other single source.

National Union gives sales promotion aids and business forms.

National Union supplies radio tubes which are acclaimed by experimenters, amateurs and service experts for their accuracy and superiority. National Union tubes never fail to build customer good will. You can quickly prove this fact to yourself as thousands have already done.

Let National Union play Santa Claus to you Mr. Service-Dealer by giving you the instruments you need and giving your customers the fine radio performance they should demand!

National Union Radio Corp. of N. Y.  
 400 Madison Ave., New York City



Tell me about.....  
 Name.....  
 Address.....  
 City..... State..... RR 1234



## CANDOHMS

STANDARD EQUIPMENT IN LEADING SETS

WIRE WOUND RESISTORS



TEN MILLION IN USE

Send Today for New Complete Catalog and Free Resistance Calculation Tables

### THE MUTER COMPANY

1255 South Michigan Ave., Chicago



WET AND DRY ELECTROLYTIC PAPER AND MICA CONDENSERS

RECOGNIZED FOR SUPERIOR QUALITY IN ALL CLIMATES THE WORLD OVER

SOLD BY LEADING JOBBERS EVERYWHERE

SOLAR MFG. CORP.  
 599 BROADWAY  
 NEW YORK

**BEST BY TEST!**  
 ASK FOR CATALOG OF EXTREMELY COMPACT TYPES HANDY FOR SERVICE



curve will instantly alter with any adjustment that is made in the trimmer condensers of the receiver. It is extremely interesting to study how these adjustments affect the selectivity curve of the receiver while it is constantly held in view.

## Interpreting Curves

Figure 2 shows a curve taken on a highly sensitive and selective receiver which had been recently aligned with the customary test oscillator and output meter. This curve was made with the test oscillator sweeping 20 k.c. off resonance each way, which is too much to get good detailed curves on a receiver with such high selectivity. Fortunately, modern instruments have an adjustment to permit the selection of band width to be examined. Before showing the

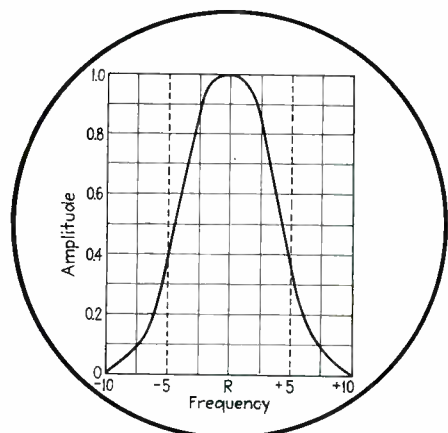

FIG. 4

effect of such adjustment though, we will note such points as can be determined from Figure 2. First, we note that the curve is "cocked," as indicated by the dissimilar distances A-A and B-B, that is, the selectivity is not the same for frequencies on the high side of resonance as for low. Second, we note at "C" a slight "humpiness" that indicates some defect in design or alignment.

The most glaring defect in the way of satisfactory performance is indicated when we sketch in the lines indicating the ideal selectivity curves for truly faithful audio performance. This has been done for a 5 kc. audio band which is now the accepted general standard and for a 7.5 kc. band which is engineering standard for high fidelity receivers. Comparing the actual receiver curve with these ideal curves we see that the audio side bands are being reduced in the i.f. amplifier to a point where no reasonable amount of compensation in the audio amplifier or the speaker response curve will ever restore them to full amplitude. In other words, the audio performance of the receiver will lack "highs." All of these points are more apparent when we cut down the width of the frequency band with the adjustment on the instrument for such purpose and the resulting curve is shown in Fig. 3.

Some will argue that, judged by high fidelity standards, this receiver contains an engineering defect with which the serviceman is not concerned. On the other hand, if some correction for this condition can

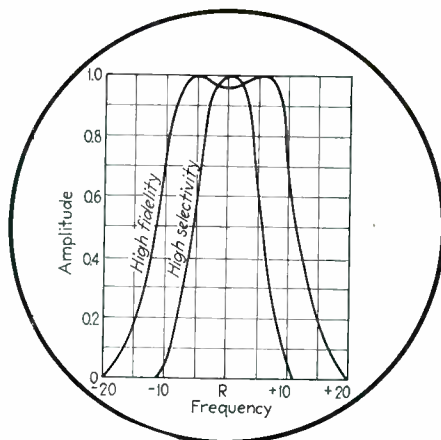

FIG. 5

be made easily and with certainty, the customer will be better pleased and agreeable to a reasonable fee for the service rendered.

## Alignment Procedure

This particular receiver contains three i.f. transformers, and the operation known as staggering them was attempted. This consists in tuning the second transformer to exact resonance, the first transformer slightly to the high capacity side of resonance and the third to the low capacity side. During such adjustments numerous unwanted humps appear when certain adjustments are carried too far, but each is seen immediately on the screen of the oscilloscope and the condition can be corrected as one goes along. The final result was a curve such as shown in Fig. 4. Staggering results in a loss of gain, but this can usually be corrected by reducing the initial bias on one of the r.f. or i.f. tubes.

It will be noted that from a fidelity standpoint the receiver has been vastly improved. The 5000 cycle side band is at .36 of the full amplitude of the curve while the original amplitude was .03, an improvement of 12 times. Adjacent channel selectivity has been slightly impaired, it is true. But, this is probably well worth while in view of the enormous improvement in the fidelity. Note also that perfect symmetry of the curve has been accomplished.

The trend in modern design appears to be toward a form of i.f. transformer and

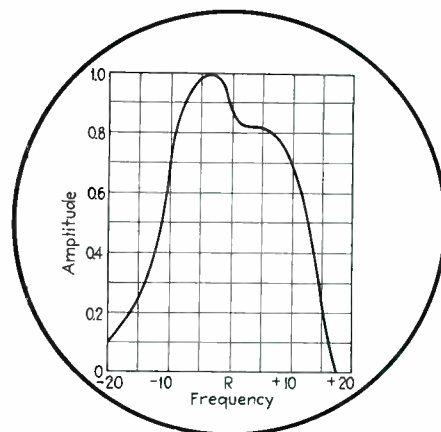

FIG. 6

circuit design which allows the customer to make his own choice between high fidelity reception and selectivity. Figure 5 illustrates the appearance of curves for the two conditions as seen in the screen of the oscilloscope. The adjustment of the curve to the proper shape on the high Fidelity setting is rather complex and too often a shape such as that shown in Fig. 6 is obtained. This requires only a slight readjustment for correction, although the amount is very apparent when any alteration in the curve, due to the adjustment, can be instantly seen.

## Vibrating Circuit-Breaker Makes Good Battery Fuse

By Irving Seideman

Most servicemen fuse the leads from a bench storage battery. When a set is being checked for a short in the A circuit the fuses blow and open the circuit or, if they have been shorted out, a heavy strain is put on the battery.

A device which is more suitable for this type of fusing is the vibrating circuit breaker, familiar to every auto electrician. In contrast with the "lock-out" type of breaker the vibrating type does not permanently open the circuit until reset, but merely limits the current flow. The Delco type 410G breaker limits flow to about 30 amperes on a short circuit. Other makes and types have different ratings.

Unexpected or accidental shorting of the battery are immediately noticed due to the audible buzzing of the vibrator under such conditions.

## Improving Tone From Output Pentodes

By Herbert J. Mayer

Sets using 47's or 2A5's as output pentodes frequently develop poor tone when the tubes have been in use for some time. It will be found that this is caused by the plate current falling slightly below normal with normal plate voltage applied. In most cases of this kind the screen-grid voltage will be found to be slightly higher than the plate voltage due to the IR drop in the primary of the output transformer.

Place a 2-watt resistor of from 4,000 to 5,000 ohms in series with the screen to correct this condition. A .5 to 2 mfd., 400 volt condenser should be connected from screen to ground, if possible. This is not necessary in all sets.

Incidentally, tubes which develop this characteristic may sometimes be used in other sets with perfect satisfaction.

# EBY

RUBBER PLUGS  
MOULDED SOCKETS  
BINDING POSTS  
ISOLANTITE SOCKETS

● The keynote of the EBY line is twenty-three years of progress and unflinching service. Your customers also know the superior performance of all EBY products. In fact they swear by them. Cash in on this fact—and on the four fast-moving items listed below.



*EBY Rubber Plugs—Male and Female. For power, audio and radio frequency circuits. Sturdily built to withstand the hardest use. Specially designed to give the highest efficiency.*

*EBY Moulded Sockets—Sturdily built to withstand frequent tube insertions and withdrawals. The EBY recessed guide ring minimizes effort and delay in inserting tubes. They lend quality wherever used.*



*EBY Patented Binding Posts—The standard of the industry. Have non-removable beads—insure a positive contact and give eye value and utility.*

*EBY Low Loss Sockets—Made of Isolantite—renowned for high frequency circuit use. Glazed upper surface—moisture proof—dust proof. A perfect socket with recessed contacts that hold securely.*



EBY quality products are clean and fresh—and they stay that way until sold, because EBY packaging is the last word in effectiveness—it places small parts out in front and on the counters where they are seen and bought. In other words, EBY products are what you want for a quick turn-over and a good profit—they are what your customers want for dependable performance.

Don't just ask your jobber for EBY packaged products—insist upon and get them. They are better known—easier to sell and more profitable.

EBY products embody the highest type of engineering. They are the standard of the Radio Industry. They are used by leading manufacturers of electrical instruments and appliances, servicemen, experimenters and set builders.

Write for Bulletin 21 describing the complete EBY line.

**HUGH H. EBY, INC.**  
2066 HUNTING PARK AVE., PHILADELPHIA, PA.

## AUTOMATIC RECORD CHANGER TWO MODELS AVAILABLE



### MODEL "L"

Plays and automatically changes eight 10" records or seven 12" records—78 R.P.M. or 33½ R.P.M.

### MODEL "K"

Plays and automatically changes eight 10" records or manually plays and repeats one 12" record—78 R.P.M. or 33½ R.P.M.

### COMPACT

Requires small cabinet space for mounting.

### REMARKABLY SIMPLE

No intricate working parts to get out of order.

### SELF-CONTAINED

Shipped complete ready to place in cabinet.

### FINISHED

in pleasing statuary bronze.

IMMEDIATE DELIVERIES MAY BE HAD

Product of

**THE GENERAL INDUSTRIES CO.**

Elyria, O.

### GUARANTEED RADIO SERVICE

requires the BEST repair parts!



## EXACT DUPLICATE ELECTROLYTIC CONDENSERS

are the BEST!

- ✓ Identical in every detail.
- ✓ Plainly marked for capacity, voltage, part number, make and model radio they are for.
- ✓ Attractive, workmanlike appearance.

TOBE condensers—like the one illustrated—are available for all popular receivers.

### TOBE DEUTSCHMANN CORPORATION

CANTON, MASSACHUSETTS



## INTRODUCING A COMPLETE LINE

of Guthman Replacement antenna, oscillator and R. F. coils for broadcast and short wave bands—antenna and oscillator coils for superheterodyne use—choke coils—intermediate frequency transformers—short-wave plug-in coils, etc.

We have been supplying a number of the leading manufacturers with original equipment. An increasing number of inquiries from parts jobbers, dealers and service men has influenced us to form a replacement parts division of our company. We are taking this department of our business seriously and have put competent engineers and sales executives in charge of this work.

As a starter, we offer *Majestic exact duplicate replacement coils*—I. F. transformers and assemblies—send for our *Majestic replacement bulletin*—the prices are competitive with any other similar replacement merchandise on the market today—and we guarantee every Guthman product.

SENT FREE—Just issued—new set of replacement bulletins.

Territories open—parts jobber appointments now being made—dealers and service men write direct if local jobber is unable to supply you.

### EDWIN I. GUTHMAN & CO., INC.

Manufacturers

1321 So. Michigan Ave., Chicago, Ill. Cable address, Simontrice: New York



## Polishing Bakelite

From the Bakelite Corporation (and what better authority?) comes this useful information regarding the polishing of bakelite panels:

"Butcher's wax is better than shoe polish. The latter doesn't hurt the material but its stickiness is apt to pick up dirt. The best way to keep a cabinet in shape, incidentally, is to sponge it off with alcohol occasionally. If a high lustre on a polished surface is desired use butcher's wax. On dull panels, where a rich matte finish is desired apply a little light lubricating oil and then carefully rub it off."

## Visual Mike V.C. Meter

By J. P. Kennedy

An ordinary a.c. 0-150-volt meter having at least 10,000 ohms resistance may be used as a volume-level indicator on a p.a. system. This meter is best connected across the 500-ohm line circuit of the amplifier, using the circuit shown, and, if

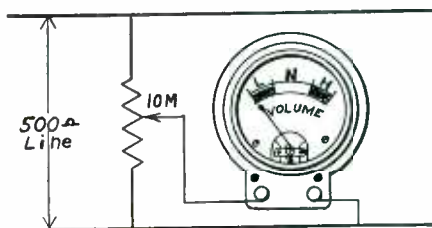

desired, a 10,000-ohm potentiometer may be connected between to permit scale adjustment. A paper scale is made and placed over the regular meter scale. Mark a colored area (green) over the first 50 volts and label this area "low." Mark (yellow) from 50 to 100 "normal" and (red) from 100 to 150 "high."

Mount the meter with a strip-type ground clamp to the microphone standard. Then make a preliminary test to determine suitable volume level. Adjust the potentiometer to match the scale of the meter to the various levels.

## Cleaning Dynamic Speakers

By C. E. Hoover

To clean dynamic speakers when pieces of metal filings become lodged around the pole piece and cause a rattle, turn the cone down on the bench and run it at slightly higher than normal volume for a few minutes. This will cause the particles to gravitate to the front edge.

Now turn off the power and run an electro-magnet around the edge of the

voice-coil, picking up the particles. A magnet suitable for this purpose can be made up of "junk-box" material. I use a discarded telephone ringer coil energized by an old B-supply unit. The stronger the field, the quicker and more thoroughly the job is done.

## Curing "Tunable" Hum

By Ralph LeBrun

Sets which hum badly only when certain stations are tuned in are quite commonly encountered on the test bench. The easiest way to determine definitely if the set itself is faulty is to operate it, volume turned to the minimum setting, and tuning a set known to be ok to the same wave. The bad set will transmit hum to the good.

In some cases, as servicemen know, such hum can be eliminated by by-passing the 110 volt line to the ground post of the receiver through a .01 to .5 mfd. condenser. A method which works in practically all instances is the connection of a .001 to .1 mfd. mica condenser from each rectifier plate to the rectifier filament. It is necessary to try different values between the sizes indicated for best results.

## Improving Duo-Diode "Sock"

By M. G. Goldberg

To improve the "punch" of sets using the 85 duo-diode triode resistance or impedance coupled to a power tube grid replace the 85 with a 75. Volume will very nearly double. In sets using the 37 as a detector or first audio stage replacement with a 76 will also improve volume.

## Template Makes All A-R's Single-Hole Mount

By Joe Long

When you sell an auto-radio installation job you're selling time. It is necessary to speed up the work as much as possible if it is to be profitable.

Have some local metal works stamp out a template of medium-heavy iron or steel. Specify a center hole large enough to accept a half-inch bolt and also other holes to take every common type of chassis mounting. Quick survey of your recent jobs will give you this data.

All sets can be quickly mounted with these plates by simply fastening them to the proper plate holes, then single hole mounting the plate. The work, most of it, can now be done quickly right on the bench.

## Replacing .1 Mike Condensers In Majestic 20 I. F. Units

By E. F. Stanton

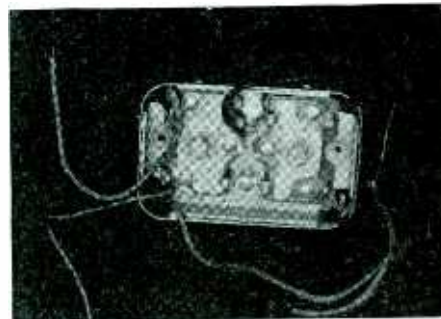

Pull the wires clear and file the rivets down until they can be punched out, as shown in the picture

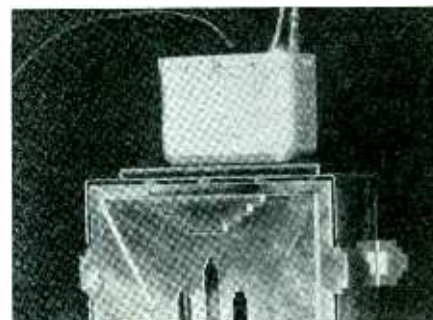

Place the unit on top of the family toaster and allow it to "cook" for 20 minutes. Then remove the interior assembly by tugging on the wire leads

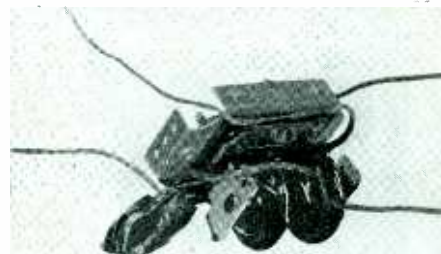

Pull the small bypass condenser away from the bracket which holds the coils and clip its retaining wire



Attach a .1 mfd., 600-volt replacement in place of the old condenser, wrap it in paper to prevent warm tar from melting the insulation. Reheat the tar and restore the assembly to the "bath-tub," anchoring it with new rivets or small bolts

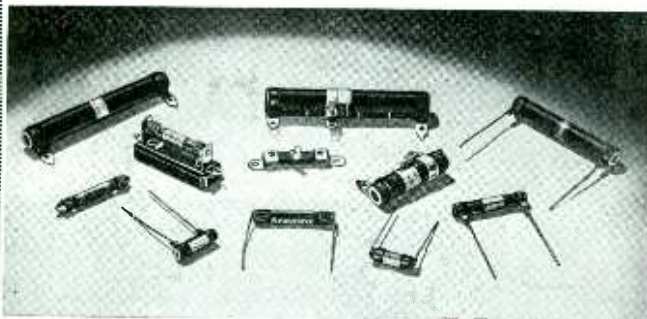

### AEROVOX for RESISTORS, Too!

Not only a complete line of condensers, but also a complete line of resistors is offered by Aerovox:

- Carbon Resistors . . . non-inductive, non-hygroscopic, unaffected by humidity changes. Choice of sizes, wattages, resistance values.
- Wire-Wound Vitreous-Enamel Pyrohm Junior Resistors . . . no larger than usual carbon types but wattage ratings of 5, 10, 15 and 20 . . . standard resistance values.
- Adjustable Pyrohm Vitreous-Enamel Wire-Wound Resistors . . . for voltage divider networks . . . for transmitters . . . for industrial needs.
- Wire-Wound Fibre Strip Resistors . . . eyelet terminals, also center taped.
- Vitreous - Enamel Resistors with all types of terminals.
- Lavite Resistors and Grid Leak Resistors . . . also mountings.

Remember this: Aerovox means one source of supply for condensers and resistors . . . one order . . . on bookkeeping entry . . . one check in payment . . . a big saving not to be overlooked!

**NEW CATALOG:** 1935 Edition just off press . . . sent on request . . . covers entire line of condensers and resistors. Also sample copy of monthly Research Worker.



74 Washington St. :: :: Brooklyn, N. Y.

110 Volts A.C. Anywhere  
In CARS... on Farms...  
In D.C. DISTRICTS with



### ATR DC-AC INVERTERS

For Operating

Standard 110 Volt A.C. radios, fans, vacuum cleaners, mixers, hair dryers, curling irons, medical appliances, etc.

**PROVEN—DEPENDABLE  
GUARANTEED . . .**

ATR DC-AC Inverters are simple, easy to use, inexpensive devices for producing standard 110 volt alternating current from 6 volt storage batteries, 32 volt farm plants, and 110 volt DC systems. No need to purchase special appliances. The ATR DC-AC Inverter will supply 110 volt AC power for operating standard AC devices.

List Price

**\$18.50**

Specify type desired.

Standard discounts apply.

Type	D.C. Input	A.C. Output	Maximum Cap.	List Price
6	6 volts	110 V. 50-60 cycles	50 watts	\$18.50
32	32 volts	110 V. 50-60 cycles	100 watts	18.50
110	110 volts	110 V. 50-60 cycles	200 watts	18.50

Special Types for various D.C. inputs, including 12 and 220 volts, can also be supplied.

Write or Wire for Additional Information  
Sold by Leading Jobbers everywhere.

Manufactured by

**AMERICAN TELEVISION & RADIO CO.**

St. Paul, Minnesota, U. S. A. Cable Address: AMTELEAD, St. Paul

### DYNATEST SPEAKER

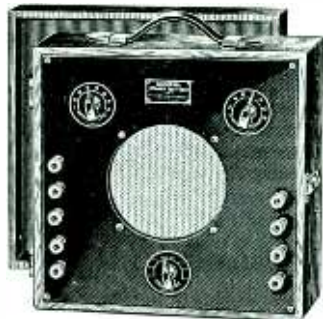

A new service aid for testing any radio chassis without the set's regular dynamic speaker. Multi-wound, tapped field coil matches requirements of any radio. Universal voice coil coupling device matches circuit of every type power tube. Easy to connect. Handy connections for output meter. Size 12x12x6". Made for Radolek by Oxford. Net price, \$13.23. Write for complete 1935 Radio Profit Guide.

**The RADOLEK Co.**  
586 W. Randolph Street, Chicago



### Thousands of Servicemen say the CONDENSER ANALYZER "simplifies radio service"



"I certainly am more than pleased with the TOBE CONDENSER ANALYZER and don't see how any real service organization could do without it. It has certainly located troubles for me which might have taken hours otherwise. I cannot praise it too highly and feel that it is a laboratory instrument—there is no guessing about the state of a condenser with this tester."

PAUL C. CONOVER, University of Illinois, Champaign, Ill.

Only \$11.40 net to servicemen.

**TOBE DEUTSCHMANN CORPORATION**  
CANTON, MASSACHUSETTS

## The Fit Still Survive

Did you ever compare the classified section of the 'phone book with the directory of the year before? It's an interesting if somewhat disheartening pastime. You find every year that some merchants have fallen by the wayside. The causes are usually bad management and poor merchandise.

Fortunately each trade has antidotes for business disaster and failure. Not the least of these antidotes are the business magazines of each trade. The editorial pages tell a merchant how to manage his business profitably—the advertising pages help a man buy good merchandise.

Try *Radio Retailing* as a prescription. Use its pages as a cure for failure, as a stimulant to business survival.

*Radio Retailing*



# SERVICE SECTION

## TRICKS of the TRADE

**AK 155.** Hum and distortion in these a.c.-d.c. midgets . . . Check dual and triple filter condensers for bad leakage and if it is found replace with 8 mike sections. Also see if volume control has changed value from normal  $\frac{1}{2}$  megohm. Before delivering to customer adjust trimmer between tuning condensers and speaker, at top front of chassis, to loudest point.

**AMERICAN BOSCH R6, R7.** Lack of selectivity . . . Disconnect antenna and ground. Connect short length of wire to antenna post. Tune to a signal between 1400 and 1500 kc. Select a weak enough signal so that the volume control may be operated at maximum. Bring signal to maximum with all trimmers and then go over them a second time. The first trimmer (extreme left from back) is extremely critical. Without moving the dial reduce the volume control and connect the regular, long antenna in place of the short wire. Then re-tune the first trimmer. Advise the user to employ a short antenna, if possible as the set trims up better on one.

**BOP CHEVROLET.** Pronounced vibrator buzz . . . Remove 75 tube. If noise stops replace tube and short screw-driver across grid to ground. If buzz continues equally loud place 4 mike condenser across B plus to ground. Trouble is due to opening up of filter output condenser.

**BRUNSWICK 15.** Distortion on all stations, reception otherwise ok. . . . Check detector screen by-pass. This often shorts out without affecting voltage readings enough to notice. Check the condenser with a neon lamp to be sure of it.

**CROSLY 124.** Breaks into oscillation when light is snapped on or off anywhere in house . . . Move wires leading from a.f. transformer to grids of 47 from between socket terminals of 27 detector and 51 i.f. screen terminal and tie them near the detector choke.

**EDISON R6, R7.** Weak signals, low plate voltages on all r.f. tubes, 1,000 ohm resistor in detector circuit gets hot (detector filter resistor is the left of the three square units in top chassis) and 3,500 ohm, 2 watt resistor in power chassis heats . . . Common cause is shorting of .05 condenser located in detector filter unit and connected from 3rd r.f. plate to ground. Weak, or no signals, low or no screen voltage on r.f. stages and hot 17,500 ohm, one watt resistor in r.f. filter unit (R.f. unit is the center unit of top chassis) . . . Invariably caused by shorted .5 mike condenser connected between 2nd and 3rd

r.f. screens to ground, located in r.f. filter unit. Pronounced rumbling or drumming sound on low audio frequencies . . . Commonly caused by voice coil striking field housing at bottom of voice coil passage. Remove speaker head assembly and insert thick cardboard washer to give voice coil more travel distance.

**FORD-MAJESTIC.** Repeated breaking or fraying of cable where set is mounted in floor . . . Use number 10 spring-steel piano wire, fishing this through from control head end of sleeve to replace old stranded cable. With this new wire slack, a troublesome feature of the stranded stuff, disappears.

**FORD-PHILCO 1934.** Periodic drop in volume accompanied by sharp click . . . Look for wires to terminals on inside of i.f. coils touching trimmer rivets and changing condenser capacities. (I.f. 260 kc.)

**GE K40A.** Weak and distorted reception . . . Most common cause is excessive leakage or total shorting of double 4 mike electrolytic condensers. The most troublesome unit is the one connected in the 25Z5 circuit, the next best bet the one in the 77 or 78 cathode circuits. Sometimes the set does not operate after these condensers are replaced. If this trouble is encountered, try changing the 25Z5 tube even though it shows up ok in a checker. If the rectifier is causing trouble usually the 38's plate current will be abnormally low while other voltages seem to be about right.

**MAJESTIC 520.** Replacing 25 with easier-to-obtain 19 . . . Looking at bottom of six-prong socket, reading clockwise from filament prongs, connections originally are as follows: Filament, filament, plate, diode, diode and grid. Change circuit connections so that the grid lead goes to the old diode prong immediately next to the plate while the diode lead removed from this prong is carried to the old grid connection. The prongs should now read: Filament, filament, plate, grid, diode, diode. (I.F. 175 kc.)

**PHILCO 87.** Instability, will not neutralize . . . The first, second and third r.f. plate circuits include resistors wound directly on .1 mfd. condensers. The .1 mike units are connected between the resistors and the r.f. primaries. Usually the first one is open, causing excessive oscillation. Check all three.

**PHILCO 19, 89.** Intermittent operation . . . Try new oscillator tube, or change cathode bias resistor from 15,000 to 10,000 ohms. Examine mica of oscillator high-frequency compensating con-

denser. If cracked replace as moisture sometimes gets in and stops operation. (I.F. 260 kc.)

**SILVERTONE 1652, 1654.** Poor selectivity in models equipped with .005 condenser in i.f. stage . . . Remove second i.f. untuned transformer underneath chassis and replace with part R6415A, a tuned i.f. transformer. Realign both i.f. stages. If set oscillates reverse connections on plate coil in second i.f. stage, being careful not to disturb connections to trimmer from plate and B-plus. Rotor must go to plus. Any good tuned i.f. input transformer which peaks at 175 kc. can be used if a Colonial part is not easily obtainable.

## SPARTON I. F.'s

MODEL	MODEL	MODEL
9-X	172.5	35
10	172.5	36
12	172.5	44-P
13	172.5	45
14	172.5	46-P
14-A	172.5	53
15	172.5	56
15-X	172.5	57
16	172.5	58
16-AW*	172.5	60
17	172.5	61
18	172.5	62
25	172.5	63
25-X	172.5	63-AX
26	172.5	65
26-AW*	172.5	65-T
27	172.5	66
27-A	172.5	66-T
27-X	172.5	67
28	172.5	68
28-X	172.5	70
30	172.5	71
30-A	172.5	71-B
30-B	172.5	72
30-C	172.5	72-PQ
33	172.5	73
33-A	172.5	73-AX
33-B	172.5	73-BX
34	172.5	74
	172.5	75
	172.5	75-A
	172.5	75-AX
	172.5	75-B
	172.5	76
	456	77
	172.5	78
	456	80
	456	81
	900	81-A
	456	82
	456	83
	456	84
	456	85-X
	456	86-X
	456	104
	456	111-X
	456	134
	345	333
	345	475-A
	456	475-AX
	478	172.5
	456	620-X
	172.5	691
	172.5	750-A
	172.5	750-X
	456	870-A
	456	870-X
	172.5	

\*The short-wave superheterodyne converter in these models operates on an intermediate frequency of 900 k.c.

**STEWART-WARNER R116AH.** I.f. trimmer requires frequent adjustment . . . Caused by expansion and contraction due to temperature. Readjustment required every 2 to 3 months where weather varies widely.

**STEWART-WARNER 950.** Set dead or no pep with excessive hum . . . Check  $\frac{1}{2}$  mfd. condenser in cathode circuit of detector, speaker field resistor and filter condensers.

**STEWART-WARNER R100A, R100B, R100E.** Distortion . . . Check 27-plate current and voltage, which should be about 3 mls. at 115 volts. If low voltage and higher mls., replace .1-mfd. tubular coupling condenser, probably leaking. Regular 100,000-ohm ohmmeter will not show it up. Condenser is connected between detector plate choke and first audio grid. It is also a good idea to replace 45,000-ohm (red), 1-watt carbon resistor connected between r.f. plates and ground (bleeder) with a 2-watt carbon job while the chassis is open, as this is a common cause of low voltage and weak reception.

# "I'm NOT clipping your coupon"

Do dealers and service men use *Radio Retailing*? . . . YES!  
Don't let this headline fool you.

## Here's the story . . .

Inadvertently our popular "Dealer Help" page in the November issue was run back-to-back with Technical Editor MacDonald's service page, "Tricks of the Trade." How the service men howled when they discovered that clipping the coupon for Dealer Help material meant cutting out five service ideas on the preceding page! But they ordered their manufacturer printed matter just the same—writing out their own order blanks.

These six letters, picked at random from 56 received, tell the story of reader interest in *Radio Retailing*:

"Not wishing to mutilate Tricks of the Trade section I am circling the numbers desired as dealer helps. Thanks for the literature."

Barties Radio Service, York, Pa.

"I did not use the coupon as I wish to keep the magazine intact for future reference."

Pioneer Radio Service, Danville, Ill.

"I am not sending coupon because it interferes with Tricks of the Trade information on the opposite side. I keep a file of such articles and card them alphabetically for reference."

M. C. Kline, Pontiac, Mich.

"I haven't got the heart to destroy my November issue to get the order blank on page 46 so am asking you by letter to send me the following numbers."

Gordon Deitrick, Courdisport, Pa.

"I hate to cut the coupon out of my November issue of R. R. since it has Tricks of the Trade on back of same and hope that above will bring me the material."

Joseph J. Pire, Colonial Beach, Va.

"What a shame to have to cut into Tricks of the Trade."

Al's Auto & Radio Shop, Lawrence, Mass.

## Incidentally . . .

407 dealers and service men requested Dealer Help material in response to *Radio Retailing's* "easy order" invitation in its October issue. These subscribers asked for 4,456 manufacturers' catalogs or display pieces, an average of 11 items per dealer. The total responses to this same editorial service, repeated in the November issue, will top this record.

**Yes . . . Its 20,000 readers  
use RADIO RETAILING**



## In Demand!

FROM the factory to the dealer to the consumer, the highest standards are observed.

Expert workmanship, dealer profit, and satisfaction to the consumer make Ken-Rad Radio Tubes popular merchandise.

Ken-Rad dealers make profit and build up trade. Details for handling Ken-Rad Radio Tubes sent on request.



## Ken-Rad Radio Tubes

**DEPENDABLE LONG LIFE**

THE KEN-RAD CORPORATION, Inc., Owensboro, Ky.  
Division of The Ken-Rad Tube and Lamp Corporation  
Also Mfrs. of Ken-Rad Incandescent Electric Lamps

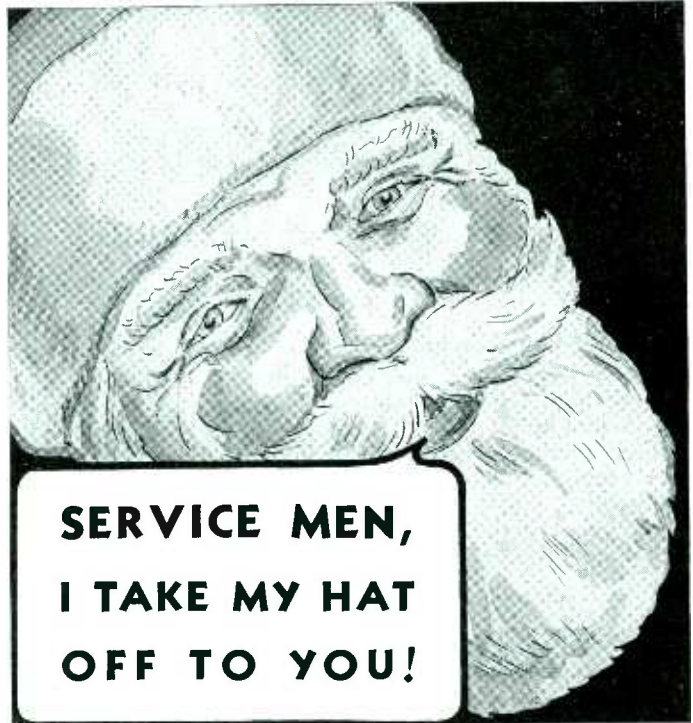

**SERVICE MEN,  
I TAKE MY HAT  
OFF TO YOU!**

**OLD SANTA** takes his hat off to you because you bring people *extra pleasure* all year around, while he is privileged to add to their enjoyment only at Christmas time.

We also take our hats off to you for the excellent work you are doing, and especially for your efforts to banish the old "3 to 4 hour day" bugaboo in the minds of so many owners of battery operated sets. Too many people still believe batteries must be used only a few hours a day if maximum service is to be received. This belief, of course, is no longer true. As you know, BURGESS Engineers have proved, in repeated tests in BURGESS Laboratories and in actual use, that you can use BURGESS Batteries 7 or 8 hours a day and get every hour of service we've built into them!

You double the enjoyment your customers can get from their battery operated sets when you bring their battery knowledge up to date. And you render a service second in importance only to your work in bringing sick, crippled sets back to vigorous health. A Merry Christmas and a New Year of even greater service to you! BURGESS BATTERY CO., Freeport, Illinois.



### BURGESS POWER HOUSE

Costs only \$3.20.  
Provides 400 hrs.  
of DRY "A"  
Power at less than  
one cent an hour!



### BURGESS "B" and "C" Batteries

Built, like the POWER HOUSE, to give long service at minimum cost per hour.



## Manufacturers and Engineers of Electrical Apparatus for Special Applications

# Janette

## Rotary Converters

The choice of the discriminating user. Janette Dynamotor Type "Double-Wound" Rotary Converters are compact in design and assure quiet operation and sustained performance equaling central station A.C. supply. These rotary converters are equipped with a special Janette filter. When used with short-wave sets, special short-wave filter must be specified. Possess every good feature required by leading radio manufacturers. In 15 sizes. Capacities from 30 to 2,500 watts. Input voltage of 6, 12, 32, 115 or 230 volts. Write for Bulletin 13-25.



## Janette Gas Engine Driven Generating Sets

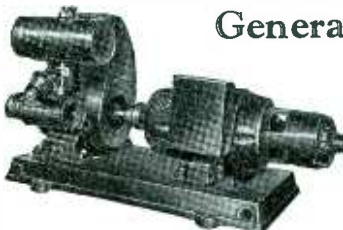

The ideal unit for operation of radios, amplifiers, sound truck equipment, public address systems, etc. 300 to 5,000 watts. Special generators and motor generators for sound, radio, public address systems, etc.

## Janette Manufacturing Company

555 W. Monroe St.

Chicago, Ill.

Cable Address: Janetteco, Chicago

# BURGESS

## BATTERIES AND FLASHLIGHTS



# LIQUIDATION SALE

## of GRIGSBY-GRUNOW CO., Inc.

### makers of *Majestic* Radios, Tubes, Refrigerators

by order of the UNITED STATES DISTRICT COURT

Pursuant to an order of the United States District Court, all of the machinery, equipment and inventory of Grigsby-Grunow Company is now being sold by the Trustee. An immediate inspection of the property is urged as sales are being made daily to many of the large concerns throughout the country.

The good will, patents, trade marks, trade names and the real estate are also being offered for sale.

The machinery consists of the very finest makes of all types of metal and wood working machinery, also a completely equipped tube, enameling and plating plant, all of which are in immediate operating condition.

The inventory consists of made-up parts, parts in process and raw materials for radios, refrigerators and radio tubes. The Service Department on all three items has been kept intact.

The GOOD WILL consists of the name "MAJESTIC" as applied to radios, refrigerators and tubes, which name has been extensively advertised throughout the world, and which is secured by copyrights in practically every country in the world including many other trade names, patents and copyrights.

The real estate consists of factory buildings having a floor area of approximately 950,000 square feet, suitable for any type of manufacturing.

The Trustee will receive offers for any part or parcels of

the assets. All machinery and materials of production are reasonably priced. Competent salesmen will be glad to assist buyers at the plant, 5801 Dickens Avenue, Chicago, Ill.

### REFRIGERATION SERVICE DEPARTMENT

The Trustee, under order of the Court, has set up a Refrigeration Service Department, to maintain service and to sell service parts. This will maintain the name and prestige of "Majestic" and be an asset of major importance to anyone buying the "good will" of the company.

### SERVICE PARTS FOR RADIOS

There is on hand a considerable quantity of service parts for radios which are staple merchandise and are being sold to the users of millions of Majestic radios now in service.

### SEND FOR THIS CATALOG

Lists all of the assets. Free to prospective buyers. Mail request to Frank M. McKey, Trustee in Bankruptcy, Grigsby-Grunow Co., Inc., 5801 Dickens Ave., Chicago, Ill.



Cat. No. 14  
List Price \$675

**CORWICO** presents  
**"NOISE-MASTER"**

An ANTENNA Kit for Combating the Objectionable "Man-made" Noises on both Short-wave and Broadcast Bands.

Also  
"Explorer"  
Cat. No. 11  
List Price... \$3.70  
"Conqueror"  
Cat. No. 12  
List Price... \$3.40  
... and there are others

THE very latest in antenna design, engineered in true CORWICO fashion. Licensed under Amy, Aceves and King patents. Includes upper and lower transformer. Permits quiet reception on one aerial by two or more sets. Combats static on both short-wave and broadcast bands. Every service organization should incorporate this valuable kit as part of its selling equipment.

Write or Wire for Particulars

**CORNISH WIRE COMPANY, Inc.**  
30 Church Street New York City

Meets the demand for a quality combination of Radio and Bar. \$95 up—complete with glassware, etc. A money-maker. Can be supplied without chassis.



# Radiobar

RADIOBAR COMPANY OF AMERICA  
LOS ANGELES, CALIF.  
New York Showroom: 13 East 47th St.

### PROFITABLE RADIO LINE

Manufacturers of a complete line of AC-DC compacts and AC midgets. We are in a position to serve distributors, dealers, and special accounts both large and small.

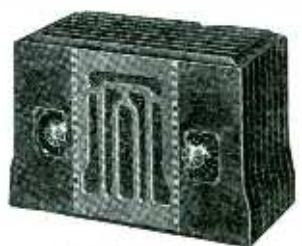

Model 44

Send for literature describing our complete 1935 line. R.C.A. and Hazeltine licensed manufacturer.

**PACIFIC RADIO CORPORATION**  
844 W. ADAMS STREET, CHICAGO, ILL., U. S. A.  
Telephone: Menroe 0133 Cable Address: Paciradio Chicago



# SEARCHLIGHT SECTION

EMPLOYMENT and BUSINESS OPPORTUNITIES—SURPLUS STOCKS—DISCONTINUED MODELS

**UNDISPLAYED—RATE PER WORD:**  
*Positions Wanted* (full or part-time salaried employment only), 10 cents a word, minimum \$2.00 an insertion, payable in advance. (See ¶ on Box Numbers.)  
*Positions Vacant* and all other classifications, 15 cents a word, minimum charge \$3.00.  
*Proposals*, 40 cents a line an insertion.

**INFORMATION:**  
*Box numbers* in care of our New York, Chicago and San Francisco offices count 10 words additional in undisplayed ads. Replies forwarded without extra charge.  
 Discount of 10% if one payment is made in advance for four consecutive insertions of undisplayed ads (not including proposals).

**DISPLAYED—RATE PER INCH:**  
 1 inch ..... \$8.00  
 2 to 3 inches ..... 7.80 per inch  
 4 to 7 inches ..... 7.60 per inch  
*Rates for larger spaces, or yearly rates, on request.*  
 An advertising inch is measured vertically on one column, 3 columns—30 inches—to a page. Radio Retailing

**SPECIAL NOTICE:**

## TO THE RADIO INDUSTRY

*Advertising in connection with legitimate offers of surplus stocks and discontinued models of radio merchandise is acceptable in this section of "Radio Retailing."*

*Extreme care will be exercised by the publishers to prevent the use of advertising in the Searchlight Section to encourage price cutting on current models of merchandise or equipment. Nor will advertising which invites violation of the dealer's contract with the manufacturer be acceptable.*

*All merchandise offered in the Searchlight Section must be accurately and fully described and must be available on order.*

**When It's Needed in a Hurry!**  
 Servicemen—Amateurs—Experimenters  
 Depend on

**BURSTEIN-APPLEBEE CO.**  
 America's Livest Radio House in America's Handiest Shipping Point.  
 1012-A McGee St.  
 Dept. 172  
 Kansas City, Mo.

**1935 Catalog**  
 148 Pages  
 Write us if you haven't a copy.

**EXPERT REPAIR SERVICE**

Microphones, meters, broadcasting equip., instruments—repaired promptly. Low prices. Estimates on request. Designers, engineers and manufacturers of Sound Equipment; Carbon and Condenser Microphones; Amplifiers; Sound Distribution and Calling Systems; Radio Transmitting Accessories; Special Multirange and High Voltage Meters and Testing Equipment. Consulting Electrical and Radio Engineers.

**SOUND ENGINEERING Corp., 2706 Kinzie St., Chicago, Ill.**

## STOP GUESSING!

Radio service is easy when you know just where to look for the troubles. A CHUCKKER trouble-graph and repair-pricer eliminates guess-work in what is wrong and what to charge. Price \$1.00 postpaid.

**FREED'S RADIO CO.**

Publishing Division E  
 5053 Baltimore Ave., Philadelphia, Pa.

## GENUINE R. C. A. PHOTOPHONE

### Dynamic Speakers

These genuine RCA Photophone Dynamic Speakers were designed for use in large theatres, dance halls, auditoriums, etc. They will take great output without distortion.



Cat. No. 161—RCA Photophone, with 12" cone heads, 1000 or 12 ohm D.C. fields, with convenient mounting holes on frame. Our Price Either Type, Special..... \$14.95

SEND FOR OUR COMPLETE CATALOG OF PUBLIC ADDRESS EQUIPMENT AND REPLACEMENT PARTS

**WHOLESALE MERCHANTISERS, Inc.**  
 8626 Broadway, New York, N. Y.

## OUR 3rd MOVE IN 14 YEARS

Thanks to our customers, the increase in our Radio Mail Order business we have experienced during the past two years has made it necessary for us to move to larger quarters.

**The AIREX CO., INC.,**  
 60 Dey Street, New York City

Send for **FREE Catalog**

### SERVICEMEN-DEALERS

"Send for our Handbook and Catalog"  
 Complete Stock of NEW Radio Replacement Parts  
 Hard to Get Parts in Stock  
 Power Packs and Speakers Repaired  
**GRANT RADIO LABORATORIES**  
 6521-R South Halsted St., Chicago, Ill.

### GENUINE GREBE PARTS

Since operations ceased at the Grebe Factory two years ago, we, the former employees and Factory Manager, have successfully carried on the Service Department of A. H. Grebe & Co., Inc., which was purchased by us in its entirety, including test equipment. Use only genuine Grebe Parts in servicing these sets. Write for *Parts Price List*.  
**C. I. VERMILYNE, 137-28 Jamaica Ave., Jamaica, N.Y.**  
 Owner and former General Factory Manager of A. H. Grebe & Co., Inc.

## SEARCHLIGHT SERVICE

Covers the Advertising of

- Agencies Wanted
- Agents Wanted
- Auction Notices
- Bids Wanted
- Books and Periodicals
- Buildings for Sale
- Business Opportunities
- Civil Service Opportunities
- Contracts to Be Let
- Contracts Wanted
- Educational
- Employment Agencies
- Foreign Business
- For Exchange
- For Rent
- Franchises
- Labor Bureaus
- Machinery Wanted
- Partners Wanted
- Patent Attorneys
- Patents for Sale
- Plants for Sale
- Positions Vacant
- Positions Wanted
- Property for Sale
- Proposals
- Receivers Sales
- Representatives Wanted
- Salesmen Wanted
- Second Hand Equipment
- For Sale For Rent
- Exchange Wanted
- Specialties
- Tutoring
- Miscellaneous For Sale. For Rent and Wanted

Address  
 Departmental Advertising Staff  
 McGraw-Hill Publications  
 330 West 42d Street, New York

### REPRESENTATIVES WANTED

**High Quality Radio Replacement Parts**  
 Sales representatives wanted. We have some desirable territories now open for representatives on our line, consisting of volume controls, carbon and wire-wound resistors and condensers. In reply state territory covered and lines now handling. RW-191, Radio Retailing, 330 West 42d St., New York City.

### WANTED

WANTED for export: 4, 5, 6, and 7 tube AC-DC sets, both short and long wave, up to 2,000 meters. Also any good items for export, under our own trade names. Uncle Dave's Radio Shack, 356 Broadway, Albany, New York.

## AGENTS WANTED BIG PROFITS

### THEATRE EQUIPMENT

New - Used - Rebuilt



Projectors, Screens, Soundheads, Amplifiers, Chairs, Portable Projectors, Arc Lamps, Rectifiers and Generators.

REPAIRING AT LOWEST RATES

**S. O. S. CORP., 1600 Broadway, New York**

S. O. S. Buys Equipment at Highest Prices

Boston, Massachusetts, jobber with established radio, hardware, furniture, and electrical appliance accounts is interested in low-priced radios and other lines as exclusive jobber or factory representative.

RA-193, Radio Retailing  
 330 West 42nd Street, New York City

## FREE SERVICE GUIDE



You need the new 1935 ALLIED Catalog! Over 100 pages devoted exclusively to Radio—listing the highest quality standard radio lines at significant savings—thousands of exact duplicate replacement parts—all leading makes of test instruments. Servicemen and Dealers—before you buy, consult the new ALLIED Catalog—it will help you give better service at bigger profits. Send for this FREE Profit Guide.

WRITE NOW Dept. SE

**Allied Radio CORPORATION**  
 833 W. JACKSON BLVD., CHICAGO, ILL.

**CONTENTS, DECEMBER, 1934**

Copyright, 1934, by McGraw-Hill Publishing Company, Inc.

Momentum .....	An Editorial	9
Will They Laugh When They Unwrap the Cello- phone .....		10
Letters to the Editor .....		11
These Three Rooms .....		12
How to Figure Your Costs .....	By John F. Rider	14
Christmas Sales Ideas .....		17
Now We Can Make Store Demonstrations that Sell To Our Foreign Friends .....	By Leslie F. Muter	18
American Radio Products Increasingly Popular Abroad .....	By R. V. Sutcliffe	20
American Broadcasts for Foreign Listeners .....		21
Export Statistics .....		22
Local Logs Bring Live Leads .....		23
News of the Month .....		24
Foreign News Notes .....		26
New Merchandise .....		28
<b>SERVICE SECTION</b>		
Circuits of the Month .....		33
How to "Read" Cathode Ray Testers By Kendall Clough .....		37
Shop Shortcuts .....		41
Tricks of the Trade .....		43

**INDEX TO ADVERTISERS**

This index is published as a convenience to the reader. Every care is taken to make it accurate, but *Radio Retailing* assumes no responsibility for errors or omissions.

Aerovox Corp. ....	42	RCA Victor Co., Inc. (Records) .....	31
American Television & Radio Co. ....	42	Sets .....	Front Cover
Arcturus Radio Tube Co. ....	3	Readrite Meter Works .....	32
Burgess Battery Co. ....	45	Rider, John F. ....	36
Cornell-Dubilier Corp. ....	36	Solar Mfg. Corp. ....	38
Cornish Wire Co. ....	46	Stromberg-Carlson Tel. Mfg. Co. ....	2
Crosley Radio Corp. ....	46	Supreme Instr. Corp. ....	34
Inside Back Cover			
Deutschmann Corp., Tobe. ....	36-40-42	Tung-Sol Radio Tube Co. ....	6
Eby Mfg. Co., H. H. ....	40	Zenith Radio Corp. ....	1
Emerson Radio & Phono. Corp. ....	7		
Fada Radio .....	5	Professional Services .....	10
Fairbanks-Morse Home Appl. ....	8		
Frigidaire Corp. ....	Second Cover	<b>SEARCHLIGHT SECTION</b>	
General Elec. Co. ....	Back Cover	<i>Classified Advertising</i>	
General Industries Co., The. ....	40	Classification .....	Page
Grigsby Grunow Co., Inc. ....	46	BOOKS .....	47
Guthman Co., Edw. L. ....	40	REPAIRING .....	47
Hygrade Sylvania Corp. ....	4	<b>RADIO STOCKS</b>	
International Resis. Co. ....	38	Airex Co., Inc., The. ....	47
Janette Mfg. Co. ....	45	Allied Radio Corp. ....	47
Ken-Rad Corp. ....	45	Burnstein-Applebee Co. ....	47
Muter Co. ....	38	Freed's Radio Co. ....	47
National Union Radio Corp. ....	38	Grant Radio Laboratories. ....	47
Pacific Radio Corp. ....	46	S. O. S. Corp. ....	47
Pierce-Airo, Inc. ....	48	Vermilye, C. I. ....	47
Pioneer Gen-E-Motor Corp. ....	36	Wholesale Merchandisers, Inc. ....	47
Radiobar Co. ....	46		
Radolek Co. ....	42		

McGraw-Hill Publishing Company, Inc., 330 West 42d Street, New York, N. Y. Branch offices: 520 North Michigan Ave., Chicago; 385 Mission St., San Francisco; Aldwych House, Aldwych, London, W. C. 2; Washington, Philadelphia; Cleveland; Detroit; St. Louis; Boston; Greenville, S. C. James H. McGraw, Chairman of the Board; Malcolm Muir, President; James H. McGraw, Jr., Vice-President and Treasurer; Mason Britton, Vice-President; H. C. Parmelee, Vice-President; Harold W. McGraw, Vice-President; B. R. Putnam, Secretary. Member A.B.C. Printed in U. S. A.

Printed by The Schweinler Press, N. Y.

**ALL-WAVE**  
**AT**  
*Skip Band Prices*



**MODEL 503A \$39<sup>95</sup>**

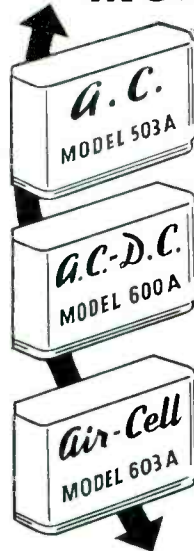

*De Wald's "3 in 1" Sets  
First to Solve Problem*

Can real all-wave sets be made at "volume" prices? De Wald is making them. Three superheterodynes—one A.C., 5-tube; one Universal A.C.-D.C., 6-tube; and one Air Cell, 6-tube. All three supplied in the duo-toned, semi-modern, American butt walnut cabinet pictured above. All three covering broadcast, police, amateur, aeroplane and foreign channels—540 K.C. to 18.5 Meg. C. All three with illuminated 3-band aeroplane dial and variable tone modulator. You've wanted honest to goodness All-Wave at medium prices. Here it is!

**DEWALD**

Licensed by RCA—Hazelton—Latour

**PIERCE-AIRO, INC.**

520 Sixth Avenue, New York

NOT CONNECTED WITH THE PIERCE ARROW MOTOR CAR CO.  
MAKERS OF FINE RADIO RECEIVERS SINCE 1921



# World's Greatest Values in Radio Receivers for 1935

Each model of the 1935 Crosley line represents the utmost in beauty and performance in its respective price field. Therefore Crosley dealers give the most for the money in any price range from a beautiful table model at \$19.99 to a gorgeous console at \$99.50. The American-Foreign and 3-Band All Wave models are exceptional values. Your nearest Crosley distributor will give you full details.

## THE CROSLY FIVER

Five Tubes . . . Superheterodyne . . . One Dual Purpose Tube . . . (6-tube efficiency) Illuminated Dial . . . Full Floating Moving Coil Electro-Dynamic Speaker . . . 510 to 1740 Kc. . . Standard Broadcasts and some police calls.

**\$19.99**  
complete

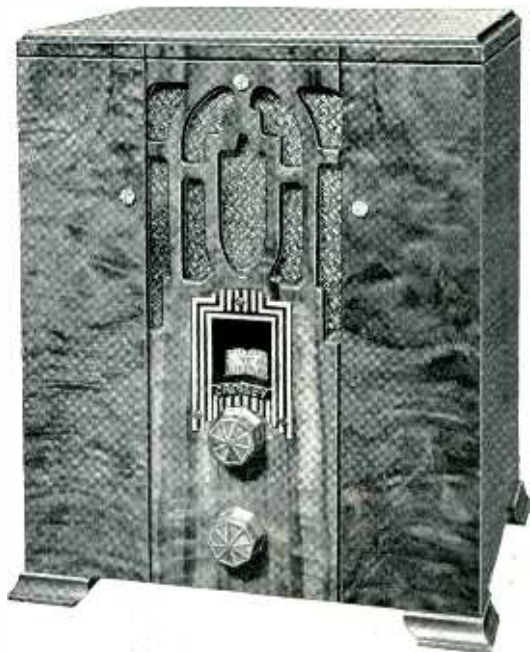

## AMERICAN-FOREIGN AND ALL WAVE MODELS at lowest prices



**Sixty-One A. F.**  
Eight-tube effectiveness, airplane type dial, automatic volume control, 3-gang tuning condenser, distinctive cabinet.  
**\$39.95**



**614EH 3-Band All Wave**  
Two double purpose tubes provide 8-tube effectiveness. Many distinctive features. Outstanding quality of tone and performance. Low in price.  
**\$49.95**



**Seventy-Two A.F. (Lowboy)**  
A 7-tube American-Foreign receiver. Uses same chassis as Seventy-Two A.F. Covers standard broadcasts from 540 to 1700 Kc. and Foreign broadcasts 5800 to 15,300 Kc. Exquisite cabinet.  
**\$79.50**

**Seventy-Two A.F.**  
Airplane type dial, automatic volume control, continuous tone control, 10-tube effectiveness.  
**\$59.95**

**714GA 3-Band All Wave**  
Same cabinet as above. 3-Band receiver for American-Foreign, police, amateur, aviation reception.  
**\$65.00**



**814FA All Wave**  
Illuminated airplane type dial, dual ratio tuning control, automatic volume control, push-pull output, continuous tone control. Gorgeous cabinet.  
**\$79.50**

**Sixty-Four MD (Lowboy)**

Uses same chassis as Sixty-One A.F. Covers standard broadcasts from 550 to 1700 Kc. and Foreign broadcasts 5,800 to 15,300 Kc. Many distinctive features.  
**\$54.50**

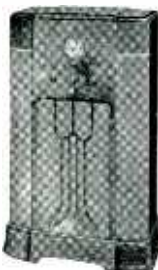

**614PG 3-Band All Wave (Lowboy)**  
Uses same chassis as 614 EH. Covers standard broadcasts from 540 to 1650 Kc., police, amateur, aviation 1650 to 5000 Kc., Foreign 5800 to 15,300 Kc.  
**\$65.00**

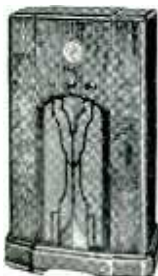

**714NA 3-Band All Wave (Lowboy)**  
An all wave, seven tube, 3-band receiver in the cabinet shown at right. Uses same chassis as 714 GA.  
**\$85.00**



**814QB All Wave (Lowboy)**  
An all wave receiver. 530 to 24,000 Kc. Houses same chassis as 814FA. A superbly beautiful cabinet. The ultimate in all wave reception. Attractive in price.  
**\$99.50**



Montana, Wyoming, Colorado, New Mexico and west, prices slightly higher.

## THE CROSLY RADIO CORPORATION

Home of "the Nation's Station"—WLW—500,000 watts—most powerful in the world—70 on your dial.



POWEL CROSLY, Jr., President

CINCINNATI

WHATEVER HAPPENS . . . YOU'RE THERE WITH A CROSLY

# CROSLY RADIO



S R OBRECHT  
513 PEISALOZZI ST  
TELL CITY IND



ENGLAND  
is calling over GSB

MEXICO  
is calling over XETE

GERMANY  
is calling over DJB

SPAIN  
is calling over EAQ

ITALY  
is calling over I2RO

ARGENTINA  
is calling over LSY



# This CHRISTMAS... sell them the WORLD!

Get your full share of the holiday sales . . .  
stock and display the complete  
General Electric All-wave Radio line.

Round-the-world reception—

That's what radio buyers want this Christmas.

But with it they want quality beyond question . . . brilliant tone . . . unclouded reception . . . ample volume . . . smartly-styled cabinets.

And they get them *all* in the new line of General Electric All-wave receivers—at prices that suit the individual pocketbook.

Headed by the superb new Bandmaster, the new General Electric All-wave line includes table models, consoles and radio-phonograph combinations, priced from \$44.95 to \$375.

Every G-E All-wave set is a thrilling performer . . . dramatically advertised in national magazines.

So if you want to be sitting on top of the world when the holiday radio buying starts, see your nearest General Electric Distributor. Or write the General Electric Co., Merchandise Dept., Section R-3612, Bridgeport, Conn.



MODEL M-5c—A five-tube standard- and short-wave receiver housed in an impressive cabinet of two-tone walnut. . . . \$59.95



THE BANDMASTER—A ten-tube all-wave receiver of extraordinary beauty and distinction. Five broadcasting bands with tuning range from 140 to 36,000 Kc. \$174.50



MODEL M-25—A twelve-tube all-wave superheterodyne with five broadcasting bands and 12 watts maximum volume out-put. . . . \$225



MODEL M-67—A six-tube all-wave receiver for domestic and foreign reception over three bands. Walnut cabinet. . . . \$89.95

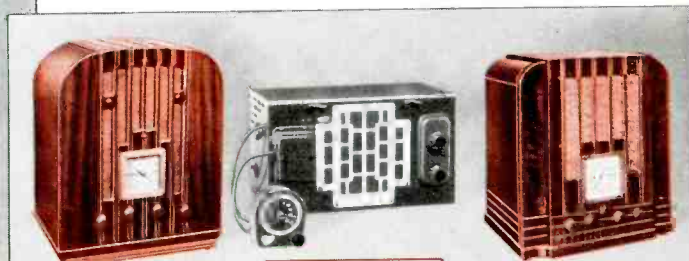

MODEL M-51—A five-tube table model with domestic and foreign broadcasting bands. \$44.95

MODEL C-61—G-E De luxe Auto Radio. An ideal gift that fits all cars. Combines ample volume with marvelous tone. . . \$59.95

MODEL M-81—An eight-tube, five-band all-wave superheterodyne. Oriental wood cabinet. \$97.50

Prices slightly higher in the West, Mid-West and South . . . subject to change without notice.

GENERAL  ELECTRIC RADIO

Born of the pioneering achievements  
of the famous "House of Magic"

